

RTCU NX-900

Advanced Industrial M2M/IoT Gateway



Introduction

The **RTCU NX-900** is the most advanced industrial IoT Gateway product available on the market today.

The device is based on the **NX32L** (NX32 for Linux) architecture, which embraces many new technologies and, at the same time maintains full backward compatibility, which ensures already implemented and tested NX32 applications can execute with no changes.

The **RTCU NX-900** is designed to meet the ever-increasing challenges on security, in that it offers full TLS on all major protocols and includes a hardened protected execution environment with dual-boot and automatic fallback and recovery.

The **RTCU NX-900** device is an industrial-grade device that is designed from the ground up for professional M2M / IoT applications with its strong on-board I/O capabilities and multiple communication interfaces such as World-wide cellular LTE, WLAN, GNSS, Bluetooth Classic / Low-Energy, Ethernet, dual RS232, dual RS485, and 1-Wire.

The on-board I/O system can be expanded almost indefinitely and completely transparently by adding Modbus I/O modules.

The **RTCU NX-900** is, to a certain extent fully software and hardware compatible with the **RTCU AX9 turbo**.

The advanced power-management features on the **RTCU NX-900** combined with the on-board high-capacity Li-Ion battery allows the device to stay in a power-saving mode for a longer period still being connected to the cellular network and capable of waking up on for example cellular activity, change of digital inputs or a vibration sensor.

This manual contains technical documentation on the installation and usage of the **RTCU NX-900** device. For detailed information on the programming and software configuration of the product, please refer to the RTCU IDE documentation.

For detailed information on the powerful RTCU M2M Platform, please refer to the **RTCU M2M Platform datasheet** and the RTCU IDE documentation.

***** THIS PAGE IS INTENTIONALLY LEFT BLANK *****

Table of contents

Introduction.....	2
Important Information.....	6
Migration from RTCU AX9 turbo:	9
Graphical overview:.....	10
Connections.....	11
Overview	11
Power supply.....	14
DC Supply.....	15
AC Supply.....	16
Digital I/O	18
Relay outputs.....	18
Digital inputs / S0 inputs / wakeup (<i>ignition</i>) input.....	19
Analog I/O.....	21
Analog inputs	21
Analog outputs	23
USB programming port.....	25
RS232 communication ports (EIA/TIA-232 and V.28/V.24 compatible).....	25
RS232 port 1	25
RS232 port 2	25
RS485 communication ports (<i>EIA/TIA-485-A compatible</i>)	26
RS485 port 1	27
RS485 port 2	27
1-Wire	28
DC-Out.....	28
5V DC-Out.....	28
12V/24V DC-Out.....	29
Ethernet	29
3D movement sensor.....	30
LED Indicators	31
User LED A and B	31
System LED S1 and S2.....	32
Switches	33
DIP-Switch.....	33
System switch (RST)	33
Internal Li-Ion battery.....	34
Worldwide LTE Cat. 4 Cellular Engine	35
WLAN and Bluetooth	35
WLAN Technical Data.....	35
Bluetooth Technical Data.....	35
GNSS receiver.....	36
High-speed link	37
ISM RF.....	38
Antennas.....	39
Cellular antenna	39
GNSS antenna	39
Wi-Fi / Bluetooth Antenna	39
RF Antenna	39

Internal SIM-Card reader	40
Micro SD-Card reader.....	40
Approved Micro SD cards	41
Product Identification Label with Barcode	42
Power consumption.....	43
Appendix A – Device configuration guide.....	45
Appendix B – Installing the SIM card	48
Appendix C – Installing the Micro SD card	49
Appendix D – Open Source Disclaimer.....	50
RTCU NX-900 Specifications	51

Important Information



Thank you very much for using a product from Logic IO Aps. Our products are designed for professional use, and therefore, this manual assumes technical knowledge and practice working with such products.

This documentation does not entail any guarantee on the part of Logic IO Aps with respect to technical processes described in the manual or any product characteristics set out in the manual. We do not accept any liability for any printing errors or other inaccuracies in the manual, unless it can be proven, that we are aware of such errors or inaccuracies, or that we are unaware of these as a result of gross negligence and Logic IO Aps has failed to eliminate these errors or inaccuracies for this reason.

This product is a complex and sensitive electronic product. Please act carefully and ensure that only qualified personnel will handle and use the device. In the event of damage to the device caused by failure to observe the information in this manual and on the device, Logic IO Aps shall not be required to honor a warranty claim even during the warranty period and shall be exempted from the statutory accident liability obligation. Any attempts to repair or modify the product also voids all warranty claims.

Please contact Logic IO for any technical or commercial inquiries:

Logic IO Aps.
Holmboes Alle 14
8700 Horsens
Denmark
Phone: +45 76250210
Support: support@logicio.com
URL: www.logicio.com

Technical Highlights

Platform:

- Based on the RTCU M2M Platform.
- **NX32L** (NX32 for Linux) execution architecture.
 - RTCU IDE development tool.
 - Operates under a full and highly optimized Linux variant.
 - Open and extendable with Platform SDK.

Hardware Core:

- Cortex-A5 32-bit ARM processor operating at up-to 500 Mhz.
- Hardware floating-point and DSP instructions.
- 128 MByte LP-DDR RAM.
- 512 MByte NAND Flash (filesystem).
- 16 MByte NOR flash (system boot).
- 128 KB SRAM with battery back-up (unlimited endurance).
- Real-time clock with battery back-up.

Security:

- Embedded firewall.
- TLS/SSL support with full certificate management.
- TLS/SSL support for all major TCP protocols, such as SMTP, MQTT, and sockets.
- Hardware assisted encryption/authentication: AES-128, AES-192, AES-256, DES, TripleDES, HASH, RND and RSA signature.

Wireless Communication:

- **Worldwide LTE Cat. 4 Multi-Band Cellular Engine.**
- Internal SIM-card reader and support for eSIM.
- **Wireless LAN** (Wi-Fi).
- Medium range **ISM band RF transceiver** with external antenna.
- Classic and Low-Energy **Bluetooth**.
- Multi-constellation **GNSS** with GPS, GLONASS, and GALILEO.

Wired Communication:

- 100 Mbps **Ethernet** LAN interface.
- **1-Wire** bus for accessories such as ID-button reader, temperature sensors, etc.
- 2 x RS232 channels and 2 x RS485 channels.

I/O Interfaces:

- **4 x analog inputs** with 0..10 volt / 0..20 mA with **12 bit precision**.
- **4 x analog outputs** with 0..10 volt / 0..20 mA.
- **5 x digital inputs** and **4 x high-power relays**.
- Up to 4 digital inputs can be configured as IEC62053-31 Class A compliant.
- Expandable I/O with standard Modbus modules.

Sensors:

- 3-axis **Accelerometer** with 16g scale.
- Temperature sensor.

User Interaction:

- 4 x bi-colour LED and 4 x position DIP-switch.
- High-speed Mini-USB service-port connector.

Audio:

- Fully digitized audio system.
- Transfer, store, and play audio.
- Digitized cellular audio.
- DTMF support for Interactive Voice Response applications.

Storage:

- Internal flash drive with up-to 512 MByte capacity.
- Persistent memory and circular datalogger.
- Standard SD-CARD reader.

Power and Battery:

- Wide AC/DC power operating range from 100..260VAC / 8..36 VDC.
- Onboard 2 Ah Li-Ion battery with intelligent charging.
- **5/12/24 Volt DC-out capability** for powering external equipment.

Encapsulation:

- Housed in a **ruggedized plastic** encapsulation with cable glands.
- **IP65** protected for outdoor usage.

Regulatory Approvals:

- Radio Equipment Directive, RED 2014/53/EU.
- EMC Directive, 2014/30/EU.
- 2011/65/EU RoHS Directive.



Migration from RTCU AX9 turbo:

There are the following differences between the RTCU AX9 turbo and the RTCU NX-900:

Topic	AX9 turbo	NX-900
DC Out	3.3 VDC	5 VDC
Digital input – S0	Enabled by default	Disabled by default
Cable glands	Three PG11 + two optional PG9	Three M20
Cellular antenna	Internal + external	External
GNSS	Not present	Built-in, external antenna
WLAN / Bluetooth	Not present	Built-in, external antenna
ISM RF antenna	Internal	External
RS485 port 2	Shared with RS232 port 1, port=0	Dedicated port, port=3
Accelerometer	Not Present	Present

Graphical overview:

There are four user-controlled LEDs and four system LEDs for simple information and status on front of the RTCUNX-900:

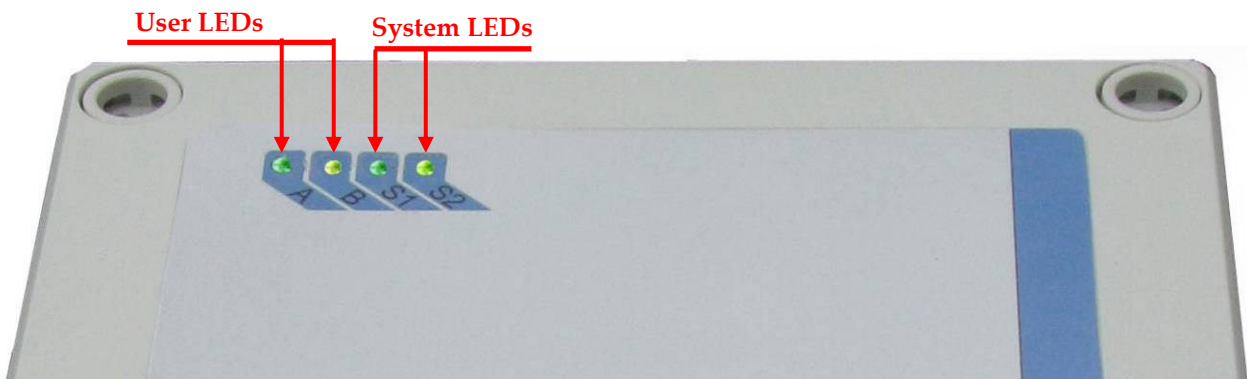

The external antenna connectors are located at the top-side of the device as shown below:



Connections

Overview

Connections to external equipment are done via large and easy-to-use screw terminal blocks which are accessible when the lid is removed. The placement of the terminals makes installation easy by using the cable glands and thereby maintaining the IP-65 protection.

The RTCU NX-900 is delivered with three M20 cable glands.

A graphical overview of the device is shown below:

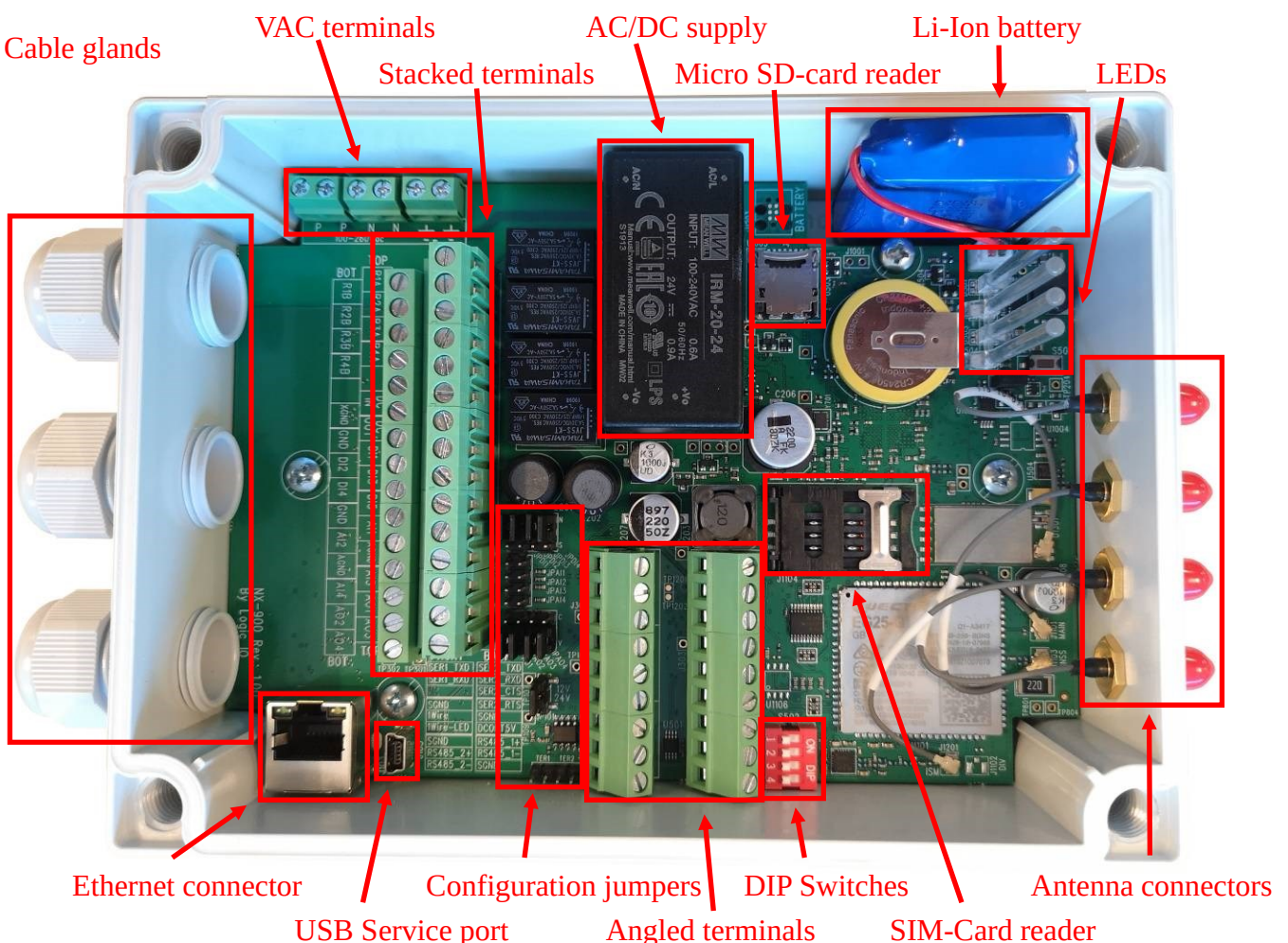

The stacked terminals contain connections for: analog and digital inputs/outputs, 12V/24 DC-Output and DC power input.

The angled terminals contain connections for the communication interfaces: RS232 Port 1, RS232 Port 2, RS485 Port 1, RS485 Port 2, 1-Wire and the +5V DC-Output.

Stacked terminal overview

Terminal Name		Description
TOP row	BOT row	
R1A		Contact set for relay output 1.
	R1B	
R2A		Contact set for relay output 2.
	R2B	
R3A		Contact set for relay output 3.
	R3B	
R4A		Contact set for relay output 4.
	R4B	
N.C		Not connected.
	N.C	Not connected.
DCIN		DC power supply, positive (+) connection.
	XGND	DC power ground, negative (-) connection.
DCOUT		12V / 500mA or 24V / 250mA DC output for external equipment.
	GND	Signal ground.
DI1		Digital input 1 / S0 input 1.
	DI2	Digital input 2 / S0 input 2.
DI3		Digital input 3 / S0 input 3.
	DI4	Digital input 4 / S0 input 4.
DI5		Digital input 5 / Wakeup (<i>ignition</i>) input.
	GND	Signal ground.
AI1		Analog input 1.
	AI2	Analog input 2.
AGND		Analog ground.
	AGND	Analog ground.
AI3		Analog input 3.
	AI4	Analog input 4.
AO1		Analog output 1.
	AO2	Analog output 2.
AO3		Analog output 3.
	AO4	Analog output 4.



Angled terminal front row overview

Terminal Name	Description
SER1_TXD	Transmit data from serial port 1, RS232 compatible.
SER1_RXD	Receive data for serial port 1, RS232 compatible.
DEV_DET	Reserved for accessories.
SGND	Signal ground.
1Wire	1-Wire bus.
1Wire-LED	1-Wire ID-Button LED output.
SGND	Signal ground.
RS485_2+	RS485 non-inverting signal for RS485 port 2.
RS485_2-	RS485 inverting signal for RS485 port 2.

Angled terminal back row overview

Terminal Name	Description
SER2_TXD	Transmit data from serial port 2, RS232 compatible.
SER2_RXD	Receive data for serial port 2, RS232 compatible.
SER2_CTS	Clear-To-Send for serial port 2, RS232 compatible.
SER2_RTS	Request-To-Send for serial port 2, RS232 compatible.
SGND	Signal ground.
DCOUT5	+5V / 300mA DC output for external equipment.
RS485_1+	RS485 non-inverting signal for RS485 port 1.
RS485_1-	RS485 inverting signal for RS485 port 1.
SGND	Signal ground.

VAC terminal overview

Terminal Name	Description
N	100-260VAC (50/60Hz) Null input.
N	<i>(internally tied together)</i>
P	100-260VAC (50/60Hz) Phase input.
P	<i>(internally tied together)</i>
	Protective earth terminal for the AC power.
	<i>(internally tied together)</i>

Connector Mini USB-B

The USB port is for programming and communication with the RTCU IDE (RACP compliant application). A standard USB cable with a connector length of 10mm on the USB-B end can be used between the device and the PC

Connector Ethernet

This is a standard 10Base-T/100Base-TX IEEE 802.3 compliant Ethernet connector. Please use an appropriate connector and cable, such as a standard CAT-5 twisted pair patch cable

Power supply

The RTCUNX-900 device can be supplied with either 100-260VAC (50/60Hz) or 8-36VDC or both supply types simultaneously.

The RTCUNX-900 also contains an internal high capacity backup battery, which will supply the RTCUNX-900 if the external power should fail or be disconnected. By default, the RTCUNX-900 is powered down when a power fail occur. This setting, however, can be changed. Please consult the RTCUNX-IDE on-line help for more information.

When the wakeup/ignition input is activated with a logical high, the RTCUNX-900 device will wake up if it was in power down mode.

There are five different ground labels: External Ground (XGND), Signal Ground (SGND), Digital Ground (GND), Analog Ground (AGND) and AC power ground (PE). The signal, digital and analog grounds are filtered from the power ground. External ground must only be used as a DC power supply return path. The AC ground is used in order to have a common reference between external AC powered system and the internal system. The digital ground is used as ground reference for digital I/O's, signal ground is used as ground reference for serial interfaces, and the analog ground is used as a low noise analog ground reference for the analog inputs.

Dual Supply Note:

The RTCUNX-900 can be supplied with both VAC and VDC at the same time. The device will run on the VAC supply if the VDC supply voltage is < +24VDC. If the VDC supply voltage is higher it will run on the VDC supply.

Please refer to the RTCUNX on-line help for information on how to check the supply type from within an application.

DC Supply

The RTCU NX-900 can be supplied with 8-36VDC from an external DC power source. Positive power is applied to the DCIN pin and ground is connected to the XGND pin.

The DC supply of the NX-900 is protected against wrong polarity. If a system ground is connected to either SGND or AGND, a wrong polarity on the supply lines will destroy the internal GND connection.

Please Note:

- Minimum 15VDC supply is necessary for 0-10V analog output and 12V DC out.
- Minimum 16VDC supply is necessary for digital inputs 1-4 to work as S0 compliant inputs.

VDC Supply terminals

Terminal Name	Description
DCIN	Power supply, positive (+) connection.
XGND	Power ground, negative (-) connection.

AC Supply

The RTCUNX-900 device can be supplied with 100-265VAC (50/60Hz) from a standard wall plug or any other high-voltage VAC power rail.

The AC supply of the RTCUNX-900 is a highly efficient switch mode power supply and the AC input is protected internally with a 2A/250V Fast Acting non-replaceable fuse.

AC power must be applied between the **N** and **P** on the designated screw terminals.

Protective Earth (**PE**) connection terminals are labeled with the sign

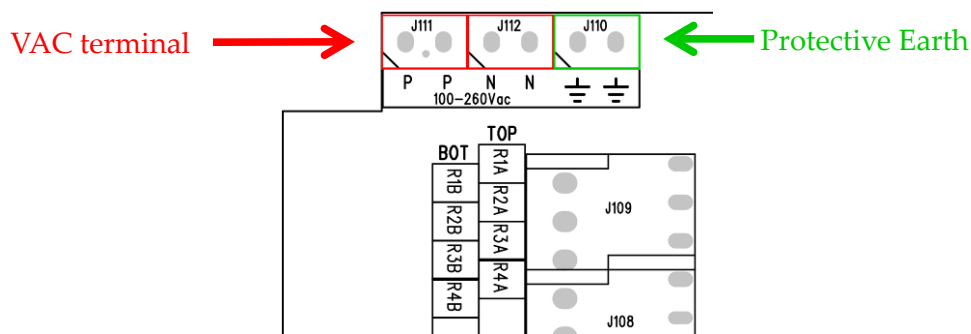

VAC Supply terminals

Terminal Name	Description
N	100-260 VAC (50/60Hz) Null input
N	(internally tied together)
P	100-260 VAC (50/60Hz) Phase input
P	(internally tied together)
	Protective Earth connector

Please Note:

The two pairs of **N** and **P** terminals, and the terminal marked with are internally connected.

There is high voltage on certain areas of the PCB (Printed Circuit Board) when supplied with AC mains. There is a risk of electrical hazard therefore avoid touching the PCB and the components during operation.



Be aware that the supply filter contains capacitors that may remain charged after the equipment is disconnected from the supply. Although the stored energy is within the approved safety requirements, a slight shock may be felt if the plug pins are touched immediately after removal.

Refer all servicing and handling to qualified personnel.

Please note:

The DC ground of the NX-900 is isolated from the AC ground because of the nature of AC-to-DC converting. As these two grounds are not tied together anywhere in the NX-900, the DC ground may appear as "floating ground" to the outside if the NX-900 ground is not connected to the same

reference as the outside and a potential difference may occur. This difference can interrupt the behavior of the device and in worst case damage that part of the device. This must be taken in consideration when the NX-900 devices are supplied with AC supply. When the NX-900 is supplied with DC voltage, this "potential difference" issue may not be observed as the DC power supply usually has the same potential as the rest of the system.

In order to avoid this, the **Earth** connection on the AC supply rail can be connected to the terminal that has been marked with the symbol ⏏ .

For circuitry in situations where significant Earth ground currents can flow isolating the DC ground from Earth grounds may be desired. In this case the DC ground may be tied together with the Earth ground through a high impedance connection.

For the best EMI performance/ESD immunity in combination with a common reference it is recommended to connect DC ground and Earth together with a low-inductance connection.

Digital I/O

The RTCU NX-900 has five digital inputs and four normally-open relay outputs. The outputs are high performance relays with good current handling capabilities.

Digital input 1-4 have multiple operating modes. Please refer to the digital input section for additional information.

Relay outputs

The digital outputs control four relays and they act like normally-open contacts, where one side must be connected to a source that needs switching and the other contact terminal is the output. The source can be either VAC or VDC but the maximum switchable voltage and current must not be exceeded. Please refer to specification page.

There are no internal connections to the relay outputs and a source must therefore always be connected to one of the relay terminals for the output to work.

The RTCU NX-900 device offers a very advanced power management which makes it possible to have one or more outputs enabled while the RTCU is in low-power mode. Please consult the RTCU IDE on-line help for more information.

Relay output terminals

Terminal Name	Description
R1A	Contact set for relay output 1.
R1B	
R2A	Contact set for relay output 2.
R2B	
R3A	Contact set for relay output 3.
R3B	
R4A	Contact set for relay output 4.
R4B	

Load noise

If highly inductive loads (such as high-power contactors) are connected to the relays, it may in certain cases be necessary to externally connect a clamping diode parallel with each inductive DC load or connect an RC snubber circuit parallel with each inductive AC load.

For DC applications Vishay UF5405-E3/54 or similar is recommended and for AC applications AMPOHM FE-SP-HDR23-47/100 (47nF/100 ohm) or similar is recommended.

Digital inputs / S0 inputs / wakeup (*ignition*) input

The five digital inputs are all low-pass filtered (**16kHz**) and transient-protected. To activate the inputs, connect a positive voltage between the corresponding input (DINx) and SGND.

Digital input 1-4 can be configured individually as S0 input (*IEC62053-31, Class A*) and DIN5 can work as wakeup (*ignition*) input.

By default, the digital inputs are configured as normal inputs. For placement and configuration of the hardware jumpers inside the device, please refer to the configuration guide in Appendix A.

S0 compliant inputs (*IEC62053-31, Class A compatible*)

In S0 configuration the relevant RTCU NX-900 input will act as a 'pulse input device', and a current is supplied into the input connector so that a simple switch between SGND and the appropriate input will activate it. This is used in most electricity metering equipment.

Please note: The NX-900 device must be supplied with a minimum of 16 VDC or AC power for the S0 mode to work correctly.

S0 is disabled by default and must be enabled by the application.

Wakeup (*ignition*) input

The DI5 / wakeup (*ignition*) input is a special input as it also functions as the ignition. If the input is activated with a logical high when the RTCU NX-900 is in power down mode, it will wake the device. A power apply will also wake the device up if it is in power-down mode.

In the other power saving modes, all the inputs and power apply/fail can be used to wake the device with individually configured falling- or rising edge detection. Please consult the RTCU IDE on-line help for more information.

The inputs are de-bounced with a period between 1-2 ms when used as a digital input therefore any logical level applied to this input must be longer than 2 ms to be valid.

For placement and configuration of the hardware jumpers inside the device, please refer to the device configuration guide in Appendix A.

Digital input terminals

Terminal Name	Description	Jumper Setting
DI1	Digital input 1 or S0 input 1	JPDI1 in position N (<i>default</i>) JPDI1 in position S
DI2	Digital input 2 or S0 input 2	JPDI2 in position N (<i>default</i>) JPDI2 in position S
DI3	Digital input 3 or S0 input 3	JPDI3 in position N (<i>default</i>) JPDI3 in position S
DI4	Digital input 4 or S0 input 4	JPDI4 in position N (<i>default</i>) JPDI4 in position S
DI5	Digital input 5 and Wakeup (<i>ignition</i>) input	
GND	Digital Ground	

Specification for each digital input

	Min.	Typ.	Max.	Unit	
Logic "High"	8	12	40	VDC	Protected against transients and low-pass filtered
Logic "Low"	-5	-	3	VDC	
Bandwidth (normal)	-	12	-	kHz	@ 12V
Bandwidth (s0)	-	4	-	kHz	
Input impedance	-	13.8	-	kΩ	@ 12V

Analog I/O

Analog inputs

The RTCUNX-900 device has four analog inputs which can be configured individually to work either as voltage or current measurement inputs by using the configuration jumper. The range in voltage mode is 0-10VDC and in current mode 0-20mA.

The conversion resolution is 12 bit.

By default the analog inputs are configured as voltage inputs and are converted to a digital value with a resolution of 10-bit before being presented to the application (0..1023). The application can change the resolution to the full 12 bit (0..4095). Please consult the RTCUNX IDE for further details.

The input signal is connected between AINx and AGND. AGND must be connected to the reference of the connected equipment. Please be aware that deviations may occur, as the system is very noise sensitive. Avoid long, unshielded wires and high current, fast changing signals routed parallel to the analog signals.

The inputs are low-pass filtered, ESD- and transient-protected.

As default the inputs are configured as voltage inputs. For placement and configuration of the hardware jumpers inside the device, please refer to the device configuration guide in Appendix A.

Analog input terminals

Terminal Name	Description	Jumper Setting
AI1	Analog input 1 – Voltage	JP AI1 not installed (<i>default</i>)
	Analog input 1 – Current	JP AI1 installed
AI2	Analog input 2 – Voltage	JP AI2 not installed (<i>default</i>)
	Analog input 2 – Current	JP AI2 installed
AI3	Analog input 3 – Voltage	JP AI3 not installed (<i>default</i>)
	Analog input 3 – Current	JP AI3 installed
AI4	Analog input 4 – Voltage	JP AI4 not installed (<i>default</i>)
	Analog input 4 – Current	JP AI4 installed
AGND	Analog ground	
AGND	Analog ground	

Specification for each analog input (voltage mode)

	Min.	Typ.	Max.	Unit	
	0	-	10	VDC	Protected against transients and low-pass filtered Accuracy is based on measurements @ 25 °C
Resolution	-	-	12	Bit	
Accuracy	-	0.3	0.5	%FSR	
Cut-off frequency	-	4.5	-	kHz	
Input impedance	-	40	-	kΩ	

Specification for each analog input (current mode)

	Min.	Typ.	Max.	Unit	
	0	-	20	mA	Protected against transients and low-pass filtered Accuracy is based on measurements @ 25 °C
Resolution	-	-	12	Bit	
Accuracy	-	0.3	0.5	%FSR	
Cut-off frequency	-	4.5	-	kHz	
Input impedance	-	504	-	Ω	

Analog outputs

The analog outputs can individually be configured to work either as voltage or current outputs. The range in voltage mode is 0-10VDC and in current mode 0-20mA. The resolution of the digital-to-analog converter is 12bit or 4096 in decimal scale.

As default the outputs are configured as voltage outputs. For placement and configuration of the hardware jumpers inside the device, please refer to the device configuration guide in Appendix A.

The default resolution is 10 bits (0.1023). The application can change the resolution to the full 12 bit (0..4095). Please consult the RTCU IDE for further details.

The output signal is connected to external equipment between AOUTx and AGND. AGND must be connected to the reference of the connected equipment. Please be aware that deviations may occur, as the system is very noise sensitive. Avoid long unshielded wires and large fast-changing signals routed parallel to the analog signals. In current mode the specifications for the analog output are only valid if the load is maximum 250Ω.

Each output is ESD and transient protected.

Please note: The RTCU NX-900 device must be supplied with minimum 15 VDC or AC in order for the analog outputs to work according to specifications.

Analog output terminals

Terminal Name	Description	Jumper Setting
AO1	Analog output 1 – Voltage	JPAO1 in position V (<i>default</i>)
	Analog output 1 – Current	JPAO1 in position C
AO2	Analog output 2 – Voltage	JPAO2 in position V (<i>default</i>)
	Analog output 2 – Current	JPAO2 in position C
AO3	Analog output 3 – Voltage	JPAO3 in position V (<i>default</i>)
	Analog output 3 – Current	JPAO3 in position C
AO4	Analog output 4 – Voltage	JPAO4 in position V (<i>default</i>)
	Analog output 4 – Current	JPAO4 in position C
AGND	Analog ground	
AGND	Analog ground	

Specification for each analog output (voltage mode)

	Min.	Typ.	Max.	Unit	
	0	-	10	VDC	Protected against transients and low-pass filtered
Resolution	-	-	12	Bit	
Accuracy	-	0.3	0.5	%FSR	Accuracy is based on measurements @ 25 °C
Input impedance	500	-	-	Ω	

Specification for each analog output (current mode)

	Min.	Typ.	Max.	Unit	
	0	-	20	mA	Protected against transients and low-pass filtered
Resolution	-	-	12	Bit	
Accuracy	-	0.3	0.5	%FSR	Accuracy is based on measurements @ 25 °C
Load	-	-	250	Ω	

USB programming port

The mini-USB port is for programming and communicating with the RTCU IDE (or other RACP compliant applications). A standard USB cable can be used between the device and the PC.

RS232 communication ports (EIA/TIA-232 and V.28/V.24 compatible)

Two general purpose RS232 ports available on the RTCU NX-900 device. Both are compliant with the EIA/TIA-232 standard.

RS232 port 1

This port is a general-purpose RS232 serial port and does not support handshaking. The signals are available on the angled front row terminals.

SER1 terminals

Terminal Name	Description
SER1_TXD	Transmit data from serial port 1, RS232-compatible.
SER1_RXD	Receive data for serial port 1, RS232-compatible.
SGND	Signal ground.

RS232 port 2

Serial port 2 is a general-purpose RS232 port with RTS/CTS handshaking signals present. The signals are available on the angled back row terminals.

SER2 terminals

Terminal Name	Description
SER2_TXD	Transmit data from serial port 2, RS232-compatible.
SER2_RXD	Receive data for serial port 2, RS232-compatible.
SER2_CTS	Clear-To-Send.
SER2_RTS	Request-To-Send.
SGND	Signal ground.

RS485 communication ports (EIA/TIA-485-A compatible)

RS485 is a multi-drop network with a maximum of 32 devices connected simultaneously to the bus. The RS485 bus contains an RS485+ (*non-inverting*) and an RS485- (*inverting*) signal as well as a signal ground which must always be connected to the common signal ground for all devices connected to the RS485 bus.

The maximum cable length for the RS485 bus is according to the EIA/TIA-485-A standard (max. 1200m @ <100kbit); this limit is highly influenced by the quality of the cable, signaling rate, noise etc.

At longer cable lengths, noisy environments, or high communication speeds, it might be necessary to terminate the transmission line with a 120¹ ohm resistor at each end of the transmission line to terminate it and avoid signal reflections.

When the RTCU NX-900 device is used as endpoint device, the hardware jumpers TER1 and TER2 can be installed to terminate the RS485 communication lines with 120Ω.

Both RS485 ports can be used as general-purpose RS485 serial port or as I/O extension module(s) port. When used with supported MODBUS IO extension modules, general purpose use is disabled. The RS485 port signals are available on the angled terminals.

Further details on the MODBUS I/O extension modules and use are available in the RTCU IDE on-line help.

By default, the RS485 communication lines are not terminated with 120 Ω. For placement and configuration of the hardware jumpers inside the device, please refer to the configuration guide in Appendix A.

¹ Assuming use of a CAT5 twisted pair cable

RS485 port 1

RS485 signals are available on the angled back terminals.

If TER1 jumper is inserted, a 120Ω endpoint resistor is enabled. For the location of TER1 refer to Appendix A

RS485 port 1 terminals

Terminal Name	Description
RS485_1+	RS485 non-inverting signal (A)
RS485_1-	RS485 inverting signal (B)
SGND	Signal ground

This RS485 port must be addressed as **port 2** when using the VPL API such as the serOpen function.

RS485 port 2

The RS485 port is available on the angled front terminals.

If TER2 jumper is inserted, a 120Ω endpoint resistor is enabled. For the location of TER2 refer to Appendix A

RS485 port 2 terminals

Terminal Name	Description
RS485_2+	RS485 non-inverting signal (A)
RS485_2-	RS485 inverting signal (B)
SGND	Signal ground

This RS485 port must be addressed as **port 3** when using the VPL API such as the serOpen function.

1-Wire

The 1-Wire bus is available on the angled front row terminals. All 1-Wire communication goes through a single connection and all 1-Wire devices connected to this connection retrieve their power directly from the bus (called parasitic power). For this only two wires are needed – the 1-wire signal and the ground reference thus allowing minimal cable installations.

For 1-Wire ID-Button readers, which include a built-in LED, a dedicated output is available for this purpose. Please consult the RTCU IDE documentation for further information.

For further information regarding modular 1-wire concept, please refer to the document “Modular 1-Wire Concept Technical Manual” on the Logic IO webpage.

1-Wire terminals

Name	Description
1Wire	1-Wire bus.
1Wire-LED	1-Wire ID-Button LED output.
SGND	Signal ground.

Specification of the 1-Wire bus:

	Max.	Unit
Total weight ¹	65	m

DC-Out

Two DC outputs are available on the RTCU NX-900 for supplying external equipment; a 5V and a 12V/24V output. It is possible to control these DC outputs in order to save power.

Both DC outputs are short circuit- (to ground), ESD- and transient-protected.

Make sure not to exceed the current specification of the outputs and be aware of inrush currents of the external equipment that may exceed the specifications.

The DC outputs must be enabled from the application. Please consult the RTCU IDE on-line manual for more information.

5V DC-Out

The +5V DC output can supply a maximum of 300 mA and is available on the angled back row terminals. This output is named boardDCOut in the RTCU online help.

¹³ The term of weight has been described in “Modular 1-wire concept – Technical Manual” document.

12V/24V DC-Out

When using the jumper JP101 either 12V or 24V DC is available on the DC-out terminal. The 12V DC output can supply a maximum of 500 mA and the 24V DC output can supply a maximum of 250 mA. The DC-Out is available on the top row of the stacked terminals. This output is named boardDCOut2 in the RTCU online help.

The 12V DC-out requires a DC supply voltage of minimum 14 VDC or AC supply to be present and the 24V DC-out voltage requires that the AC supply is present.

The jumper that switches the DC-out voltage level between 12V DC and 24V DC is located front of the communication terminal rows as shown below:

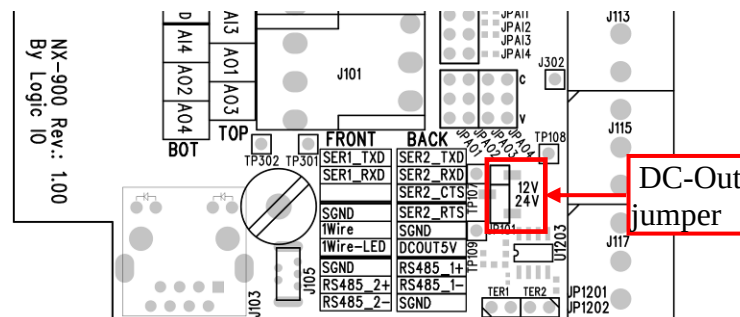

DC-Out terminals

Terminal Name	Description
DCOUT5	+5V / 300 mA DC output for external equipment.
DCOUT	+12V/ 500 mA / +24V/250 mA DC output for external equipment.
SGND	Signal ground.

Ethernet

The RTCU NX-900 offers an on-board IEEE 802.3 compatible 100BASE-T Ethernet MAC controller and transceiver for communication with peripherals and back-end systems over standard Ethernet. Please refer to the RTCU IDE documentation for details on the usage of this interface.

3D movement sensor

The RTCUNX-900 device contains a 3-axis accelerometer in order to detect vibration and motion. It makes it possible to detect movement and position change in 3 directions, X-Y-Z with a force as high as 16g in acceleration.

Please consult the RTCUNX-900 IDE documentation for more detailed information.

The positions of the three axes are as following:

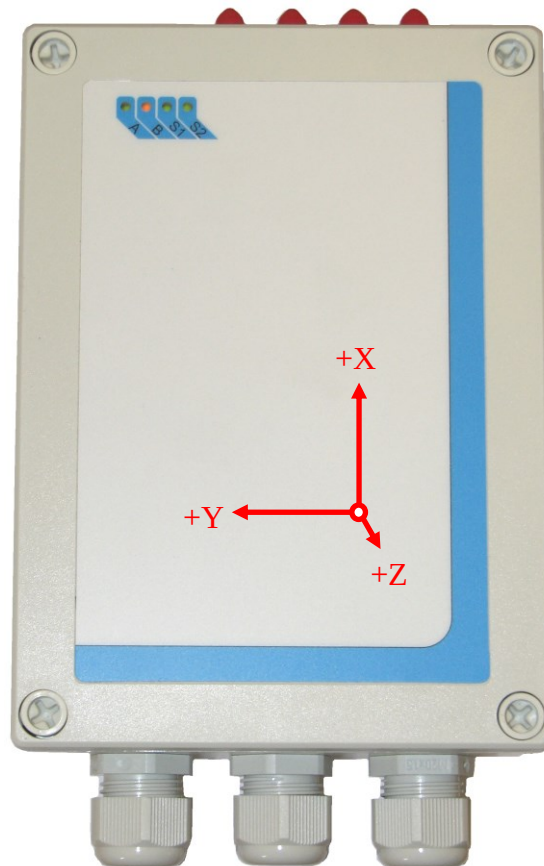

Specification:

		Unit	
Resolution	±16	g	The acceleration can be set as relative to motion,
Precision	12	bit	or relative to earth gravity

LED Indicators

Four bi-colored (red and green) LED indicator is present on the front of the device (see graphical overview).

Two bi-colored LED's (A and B) are available to the user, and the remaining two LED's (S1 and S2) are signaling the status and possible errors of the RTCU device.

User LED A and B

LED A and B are composed of four individually controllable LEDs:

- LED named A on the front consists of LED 1 (green) and LED 2 (red).
- LED named B on the front consists of LED 3 (green) and LED 4 (red).

They are easily accessed from within the application program, and it is possible to mix the LED's to obtain a third color: yellow. Please consult the RTCU IDE documentation for more information.

System LED S1 and S2

The RTCU is equipped with two system LED's, which shows the status and possible errors of the RTCU device.

The different patterns are listed in the table below. If the color of the system LED S1 is yellow, the device is actively communicating with the RTCU IDE (or another program, supporting the RTCU RACP protocol).

The LED S2 is signaling either the cellular module activity or if all other LED's are off, that the RTCU is in the "wait for event" low power state.

S1: System LED1 pattern overview

Pattern	Description
Fastest blinking, green	The device is initializing, preparing to start the application.
Fast blinking, green S2 On, green	The device is installing an update. Depending on the kind of update, it may take some time. The progress can also be observed on the display.
Fast blinking, green ¹	The device has been forced into recovery mode with the use of the system switch. The application is not executing.
500ms On / 500ms Off green ¹	The device is executing the application program
1.5s On / 0.5s Off. green ¹	The device is executing the application program, while charging the internal back-up battery.
Fast blinking, red ¹	A runtime error has been detected in the program. Use the RTCU IDE to obtain the fault log.
Alternating Fast/Slow, red ¹	The device has lost its firmware! This can only happen if, during a firmware upgrade, the RTCU device loses power or the communication is lost completely. In this case, simply upload the firmware to the device again.
75ms On / 925ms Off, green	Execution speed is different from full-speed.
On yellow (and all other LEDs OFF)	The device is booting, initializing the system

¹ Or yellow when communicating with the RTCU IDE or another program, supporting the RTCU RACP protocol).

S2: System LED2 pattern overview (cellular activity and “Wait For Event”)

Pattern	Operating Status
Off	The cellular engine is turned off
600 ms On / 600 ms Off green	Missing SIM card or PIN code. Network search and logon in progress.
75 ms On / 3 s Off green	Logged on to the network.
75 ms On / 75 ms Off / 75 ms On / 3 s OFF green	A Packet/GPRS session is active.
Flashing green	Indicates Packet/ GPRS data transfer.
On green (and all other LEDs OFF)	The system is booting into recovery mode
10 s OFF / 50 ms ON green (and all other LEDs OFF)	The RTCU device is in low-power “Wait For Event” state.

Switches

DIP-Switch

The RTCU NX-900 device contains four dipswitches, where three of them are available for the application to use. The dipswitches are located inside the device (*see drawing below or graphical view*).

System switch (RST)

The RTCU NX-900 device contains a combined reset/diagnostic switch. This switch is accessible from the inside of the device.

By activating the switch shortly, the RTCU device will do a complete reset as if the power was removed and reapplied.

If the reset switch is held down for approx. 3 seconds¹ the device will instead enter recovery mode² where the application will not be started. In recovery mode, the system will automatically turn on any communication channel and establish a connection to the RTCU Gateway (if configured).

Pressing reset will also activate the device when in power-down mode. If external power is removed and the backup battery is disabled, the reset switch can still be used to boot into recovery mode, as long as there is enough power left on the battery.

¹⁵ System LED S2 will flash green three times when this state is entered.

²⁶ System LED S1 will indicate this state by fast blinking green or yellow.

Internal Li-Ion battery

The RTCUCX contains an internal Li-Ion battery for operation even when the external power is absent making it possible to report power loss etc. Please note that when external power is removed, the device will be powered down by default. This setting can be changed as documented in the RTCUCX IDE documentation.

The battery charging is completely automated and handled internally by the RTCUCX device – leaving no need for user interaction. Different kinds of functions (Battery low, Charger enable, charging status, etc.) are available to the user application.

The charge current is relatively high, for a shorter charge time, as specified in the technical specification. Make sure both power supply and cables can handle the high current.

The battery will be charged whenever a power fail has occurred to establish the capacity thus making the battery ready for the next power fail. A maintenance charge will start every 20 days after the last charge. This is to compensate for the battery self-discharge etc.

By default, the battery cannot be charged above 45°C or below 0°C. The RTCUCX offers charging down to -10 °C using a specialized algorithm to protect the battery.

If the temperature is above 45°C the charging will not start and will be postponed until it is below this threshold.

The temperature has a very high influence on the battery capacity. At 0°C the capacity has dropped to 60% of the initial capacity and it falls dramatically at lower temperatures.

The battery cycle (numbers of charges and discharges) also influences the capacity. After 300 cycles the capacity has dropped to approximately 80% of the initial capacity.

Warning

Misusing the RTCUCX device may cause the built-in battery security circuit to be damaged.

- *Do not place the RTCUCX device in high temperature locations such as in direct sunlight or near engines. Using the RTCUCX device in this environment may result in loss of battery performance and a shortened life expectancy.*
- *Do not expose the device to water, saltwater or allow the battery to get wet.*
- *Avoid strong impacts and shocks.*

For more information regarding the environmental limitations, see “RTCUCX NX-900 Specifications” below or consult the RTCUCX NX-900 datasheet.

Worldwide LTE Cat. 4 Cellular Engine

The RTCU NX-900 uses an LTE/UMTS/HSPA engine with the following features:

- Max. 150Mbps down / 50Mbps upload (Cat 4)
- LTE-FDD: B1/ B2/ B3/ B4/ B5/ B7/ B8/ B12/ B13/ B18/ B19/ B20/ B25/ B26/ B28.
- LTE-TDD: B38/ B39/ B40/ B41
- WCDMA: B1/ B2/ B4/ B5/ B6/ B8/ B19
- GSM: 850/900/1800/1900 MHz
- SMS (Text and PDU)
- UMTS release 7, max. 42Mbps down / 5.76Mbps upload, (Cat 6)
- Digitized audio / DTMF capability.

WLAN and Bluetooth

The RTCU NX-900 device contains a combined Wi-Fi and Dual-mode Bluetooth radio that shares the same antenna interface.

WLAN Technical Data

- WLAN at 2.4 GHz ISM band
- IEEE 801.11b/g/n/d/e/h/i
- WPA/WPA2 certification
- Up-to 150 Mbps

Bluetooth Technical Data

- Classic and Low-Energy (LE) Bluetooth
- Bluetooth 2.1 + EDR up-to 3Mbps
- Bluetooth 3.0 and 4.0 Dual-mode
- Intelligent co-existence with Wi-Fi

GNSS Receiver

Qualcomm Cellular GNSS engine

General:	55 tracking channels. Multi GNSS engine for GPS, GLONASS, GALILEO and QZSS	
Update Rate:	NMEA @ up-to 4 Hz	
Accuracy:	Position	<2.5m CEP-50.
	Velocity	<0.1m/s
Sensitivity:	Tracking/navigation	-157 dBm
	Reacquisition	-158 dBm
	Cold Start (Autonomous) (Chipset reference parameters)	-145 dBm
Time-To-First-Fix ¹ :	Autonomous Operation in Standard Sensitivity Mode	
	Reacquisition ²	< 1 sec.
	Hot Start ³	< 2 sec.
	Warm start ⁴	< 26 sec.
	Cold start ⁵	< 35 sec.
Interface protocol:	NMEA 0183 v3.01 with GGA, VTG, GLL, GSA, GSV and RMC.	

¹ All satellites at open sky.

² Time to get a fix when signal has been blocked for a short period of time.

³ The GNSS engine has been powered down for less than 2 hours and the stored position and time are valid.

⁴ The GNSS engine has been powered down for more than one hour, but has stored information about its current position and time.

⁵ The GNSS engine has no valid navigation data.

High-speed link

The cellular engine and the WLAN/Bluetooth interface shares the same high-speed link to the processor of the system. This high-speed link is used exclusively by the WLAN/Bluetooth interface and may also be used by the cellular engine. When used by the WLAN/Bluetooth interface, it is not possible to use it at the same time with the cellular engine. The cellular engine works by default on a standard speed communication link that can be changed with 'HS' parameter to `gsmPower()`. Please refer to the RTCU IDE on-line documentation for further details.

ISM RF

The RTCU NX-900 is provided with an ISM band RF module which gives the device the ability to communicate with other devices wirelessly. The device communicates in the 868 MHz frequency band. The RF module hardware is set up to comply with the European EN 300 220 requirements. Please consult the RTCU IDE on-line help for more information on how to configure the RF module.

In the table below the specifications of the RF module is shown:

RF module specifications

Data	Min.	Typ.	Max.
Output Power	-30 dBm	+10 dBm	+12 dBm
Frequency	779 MHz	869,4 MHz	928 MHz
Modulation *	-	GFSK	-
Baud Rate	0.6 Kbaud	38,4 Kbaud	600 Kbaud

Please Note: Listen Before Talk (LBT)¹ functionality to comply with EN 300 220 is implemented in the RF module. If the device is installed in an environment with disturbances in the same frequency band, difficulties in RF transmission will be observed.

* Supported modulations are 2-FSK, 4-FSK, GFSK, MSK, ASK and OOK.

¹ LBT is a term used in radio communication whereby a radio transmitter senses its radio environment before it starts a transmission

Antennas

Cellular antenna

The RTCU NX-900 device contains an SMA female connector for connecting a suitable antenna. When installing the antenna, please make sure that the antenna is not in close proximity to metallic parts or anything else that can influence the efficiency of the antenna. Please consult the installation guide that follows the antenna.

GNSS antenna

The RTCU NX-900 supports GPS and GLONASS so a suitable GNSS antenna must therefore be used. The connection is with a SMA connector and the GNSS antenna must be a 3V active antenna with a SMA male connector.

The antenna must be a “DC-open” type antenna (DC-impedance between signal and ground must be at the MΩ level). Failing to use a suitable antenna may result in inferior performance or spurious antennas short-circuit detection.

When installing the antenna, please make sure that the antenna has a reasonable view of the sky, so that it can receive the weak signals from the satellites. Please also consult the installation guide that follows the antenna.

Wi-Fi / Bluetooth Antenna

The RTCU NX-900 device contains an RP-SMA connector for connecting a suitable Wi-Fi / Bluetooth antenna. The Wi-Fi and Bluetooth communication circuit shares the same antenna, so only one single antenna is required.

When installing the antenna, please make sure that the antenna is not in close proximity to metallic parts or anything else, that can influence the efficiency of the antenna. Please consult the installation guide, that follows the antenna

RF Antenna

The RTCU NX-900 device contains an SMA connector for connecting suitable 868 MHz RF antenna.

When installing the antenna, please make sure that the antenna is not in close proximity to metallic parts or anything else, that can influence the efficiency of the antenna. Please consult the installation guide, that follows the antenna

Internal SIM-Card reader

The RTCU NX-200 device contains a standard mini-SIM card reader which is located inside the device (see drawing below or graphical overview) and is easily accessed. The SIM card reader is lid based with a mechanical lock system for secure installation of the SIM card. Please refer to Appendix B for the SIM card installation guide. The RTCU NX-900 is prepared for eSIM internally, which shares the SIM-card signals with the SIM-reader. Please contact Logic IO for this option.

If the SIM-card is removed during cellular operation, the device will be rejected from the network shortly after.

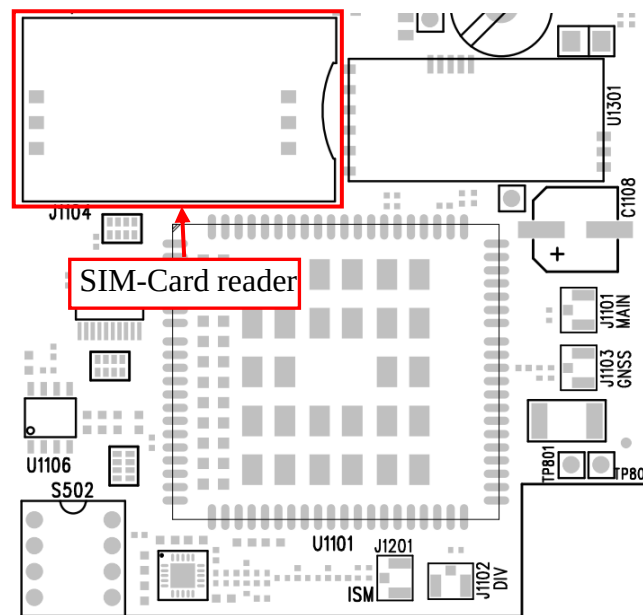

Micro SD-Card reader

The RTCU NX-900 device has a standard Micro SD card reader which is located inside the device (see drawing below or graphical view). The Micro SD card reader is a lid-based system with a mechanical lock for reliable insertion and operation.

The RTCU NX-900 supports a FAT filesystem for standard PC-compatibility with up to 32 GB capacity support. Please refer to Appendix C for SD-Card installation guide.

Both the card detect, and the write protect¹ information is available to the user through the application. Please consult the RTCU IDE on-line help for more information. Avoid removing the Micro SD card during access to the card.

¹ This signal is not available, but for compatibility reason the software function will always return "not write protected".

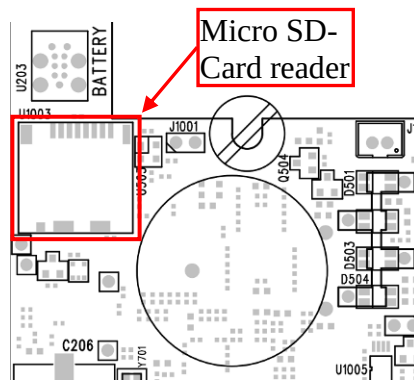

Approved Micro SD cards

To ensure the highest performance and compatibility it is important to use SD-CARDS that have been approved and tested by Logic IO.

Commercial grade SD-CARDS can be used in applications where the limited write endurance is acceptable - for example if the SD-CARD is often replaced. Commercial grade SD-CARDS should *not* be used in applications where a potential failure on the media is considered mission critical.

For applications that use the SD-CARD media extensively and where a failure is critical, it is recommended to use approved **Industrial Grade** SD-CARDS.

Logic IO has approved and recommends industrial grade SD-CARDS from **ATP** that is available in capacities from 512 MB to 32 GB.

ATP Industrial Grade SD/SDHC Cards are optimized for demanding industrial applications with consistent performance in all conditions. ATP uses reliable SLC flash technology with a flash endurance more than 20 times higher than commercial grade products with MLC flash.

The differences in write endurance between commercial grade MLC flash and ATP Industrial grade SLC flash are quite remarkable for write-intensive applications:

Product Line	Details	Total Writeable Data Prediction @ 1GB	Time Prediction @ 500 writes a day (1GB)
ATP Industrial Grade	SLC Flash	80,000GB	5,740 days
	+ Advanced Wear Leveling	or 2,800,000 writes	or 15.7 years
Commercial Grade	Grade A MLC (2 bits per cell)	4,000GB	280 days
	+ Advanced Wear Leveling	or 140,000 writes	

Product Identification Label with Barcode

The RTCU NX-900 product identification is found on the exterior of the device and contains a unique serial-number in readable form and as a barcode.

The first three digits in the serial-number identify the device type, and for the RTCU NX-900 device this unique code is **331** or **334**.

The barcode format used: 2/5 Interleaved with Check Digit

Power consumption

The table below shows detailed information about the typical power consumption for the RTCU NX-900 device while it is running.

DC power consumption: Device operating in normal mode

	12V	24V	BAT		
Device active	70	35	180	mA	
Device active with Cellular on*	110	55	300	mA	idle @ -63dBm* (2G)
Device active with GPRS session*	300	120	800	mA	@ -65dBm, Battery not charging*
Device active with GNSS on	100	55	280	mA	Mode 3
Device active with WLAN on	100	55	300	mA	Connected to AP, in idle
Device active with Ethernet on	100	45	310	mA	Connected to switch, in idle
Device active with RF sending.	75	40	190	mA	
Device active while charging	620	310	-	mA	

Note: Values marked with (*) is average and should be considered as guidelines as they may vary depending on the cellular signal strength.

Note: Power consumption from a fully charged battery.

AC power consumption: Device operating in normal mode

	220V AC		
Device active	1	W	
Device active with Cellular on*	2.5	W	idle @ -63dBm* (2G)
Device active with GPRS session*	4	W	@ -65dBm, Battery not charging*
Device active with GNSS on	2.5	W	Mode 3
Device active with WLAN on	1.5	W	Connected to AP, in idle
Device active with Ethernet on	1.5	W	Connected to switch, in idle
Device active with RF sending.	3.5	W	
Device active while charging	9	W	

Note: Values marked with (*) is average and should be considered as guidelines as they may vary depending on the cellular signal strength.

The table below shows detailed information about the typical power consumption for the RTCU NX-900 device when it is in power-saving modes.

The following power-saving modes are used:

- Mode 1: LED blinks every ~10 s, resumes the application when it is awoken.
- Mode 2: Does not blink, resumes the application when it is awoken.
- Mode 3: Does not blink, resets the device when it is awoken.

See the RTCU IDE on-line manual for information about how to use the power saving modes.

DC power consumption: Device operating in power-saving modes

Wake-up source:	Mode 1			Mode 2			Mode 3			mA
	12V	24V	BAT	12V	24V	BAT	12V	24V	BAT	
Cellular	20	10	50	-	-	-	-	-	-	mA
RS232 1 mode 0	4.5	2.4	14	-	-	-	-	-	-	mA
RS232 1 mode 1	4	2.2	13	-	-	-	-	-	-	mA
RS232 2 mode 0	5	2.7	15	-	-	-	-	-	-	mA
RS232 2 mode 1	4.5	2.5	14	-	-	-	-	-	-	mA
RS485 1	4.5	2.5	15	-	-	-	-	-	-	mA
RS485 2	4.5	2.5	15	-	-	-	-	-	-	mA
RF	8	4.5	20	-	-	-	-	-	-	mA
Vibration	1.1	0.7	3.5	-	-	-	-	-	-	mA
Din 1-4 S0	12	10	-	-	-	-	-	-	-	mA
Din 1-5	1.1	0.7	3	0.8	0.5	2	0.5	0.35	1.5	mA
Power Failure	1.1	0.7	3	0.8	0.5	2	0.5	0.35	1.5	mA
Power Apply	1.1	0.7	3	0.8	0.5	2	0.5	0.35	1.5	mA
Time	1.0	0.6	3	0.8	0.5	2	0.5	0.35	1.5	mA

Note: If wake-up on both power fail and power apply are enabled, mode 2 and 3 are not supported.

Note: Power consumption from a fully charged battery.

Note: The RS232 ports have support for two different wake-up configurations. Mode 0 will wake on valid data while mode 1 will wake on any change on the interface.

Note: The power consumption for wake on S0 will be drawn as long as S0 is enabled.

AC power consumption: Device operating in power-saving modes

The power consumption from external AC is less than 1 W in all the power saving modes.

Appendix A – Device configuration guide

The RTCU NX-900 has many features and some of them require configuration by using hardware jumpers inside the device. A brief overview over the jumper settings can be found in the following table.

Feature	Jumper	State	Default state
Communication	TER1 (RS485_1)	Installed	120Ω resistor enabled.
		Not installed	120Ω resistor disabled (<i>default</i>).
	TER2 (RS485_2)	Installed	120Ω resistor enabled.
		Not installed	120Ω resistor disabled (<i>default</i>).
Analog input	JPAI1	Installed	AI1 current measurement.
		Not installed	AI1 voltage measurement (<i>default</i>).
	JPAI2	Installed	AI2 current measurement.
		Not installed	AI2 voltage measurement (<i>default</i>).
JPAI3	Installed	AI3 current measurement.	
	Not installed	AI3 voltage measurement (<i>default</i>).	
JPAI4	Installed	AI4 current measurement.	
	Not installed	AI4 voltage measurement (<i>default</i>).	
Analog output	JPAO1	Position C	AO1 current.
		Position V	AO1 voltage (<i>default</i>).
	JPAO2	Position C	AO2 current.
		Position V	AO2 voltage (<i>default</i>).
JPAO3	Position C	AO3 current.	
	Position V	AO3 voltage (<i>default</i>).	
JPAO4	Position C	AO4 current.	
	Position V	AO4 voltage (<i>default</i>).	
Digital input	JPDI1	Position S	DI1 S0.
		Position N	DI1 normal (<i>default</i>).
	JPDI2	Position S	DI2 S0.
		Position N	DI2 normal (<i>default</i>).
JPDI3	Position S	DI3 S0.	
	Position N	DI3 normal (<i>default</i>).	
JPDI4	Position S	DI4 S0.	
	Position N	DI4 normal (<i>default</i>).	
DC-Out voltage	JP101	Position 12V	12V DC out.
		Position 24V	24V DC out.

TER1 and TER2

Enables/disables on-board 120Ω line termination resistors which are according to standards; RS485 communication requires a proper line termination value (120Ω *assuming a CAT5 twisted pair cable is used*) resistors in both ends of the bus. If the RTCUNX-900 device is used as endpoint, the relevant jumper can be installed.

JPAI1, JPAI2, JPAI3 and JPAI4

These jumpers are used to select between current and voltage input. With a jumper installed on the relevant analog input, it will measure current between 0-20mA.

JPAO1, JPAO2, JPAO3 and JPAO4

These jumpers are used to select either current or voltage output. With the relevant jumper installed in position "C" the output is a current between 0-20mA, when installed in position "V", output is a voltage between 0-10V.

JPDI1, JPDI2, JPDI3 and JPDI4

These select either normal or Class A S0 input for DIN1-4. With the relevant jumper installed in position "S", the input is configured to S0 when installed in position "N", the input is a normal digital input.

12V and 24V

These jumpers are used for connecting the DC OUT terminal to 12V or 24V.

Appendix B – Installing the SIM card

The SIM card reader is a lid-based type with a mechanical lock for secure installation of the SIM card.

Open the hinged lid of the SIM card reader, orientate the card as shown below, and insert it into the lid of the card reader. Close the lid and slide the metal locking mechanism to the locked position, as shown with an arrow and text on the lid until a click is heard.

To remove the card, slide the metal locking mechanism to the unlocked position as shown with an arrow and text on the lid and open the lid. The SIM card can now be removed.



SIM card orientation.

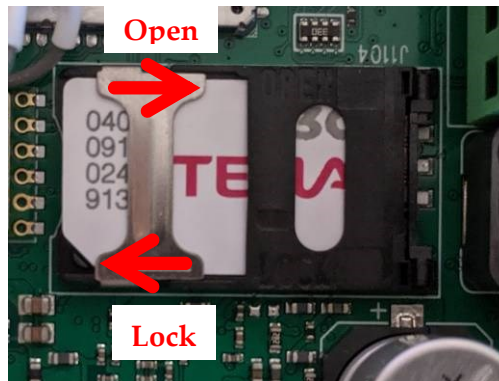

SIM inserted and locked

Appendix C – Installing the Micro SD card

To insert a Micro SD card into the reader, open the hinged lid of the card reader, orientate it as shown below, and push the card into the lid. Close the lid and slide the metal lid in the direction that is shown with an arrow on the lid until a click is heard.

Remove the card by sliding the lid in the direction that is shown with an arrow on the lid and then open the lid. Avoid removing the Micro SD card during access to the card.



Micro SD card orientation.

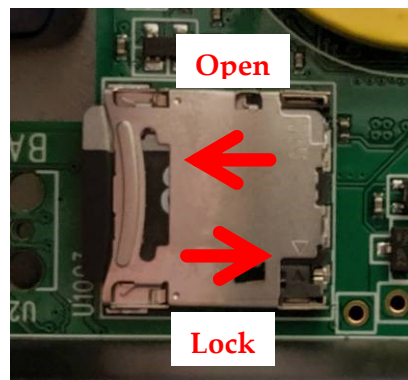

Micro SD card inserted and locked.

Appendix D – Open Source Disclaimer

The RTCU NX-900 products include several open source software tools. This open source software is governed by the terms and conditions of the applicable open source license, and you are bound by the terms and conditions of the applicable open source license in connection with your use and distribution of the open source software in this product.

Please refer to the separate document "**RTCU Open Source Licenses.pdf**" for detailed information about the packages used in the RTCU NX-900 product.

RTCU NX-900 Specifications

RTCU M2M Platform

- NX32 for Linux - NX32L.
- Fully NX32 compatible.
- Larger capacity and higher performance compared to NX32.
- Open and user-extendable API.
- RTCU M2M Platform SDK.

NX32L Hardware Core

- Cortex-A5 32-bit ARM processor.
- Hardware floating point and DSP.
- 128 MByte LP-DDR RAM.
- 512 MByte NAND flash.
- 16 MByte NOR flash.
- 128 KByte SRAM with battery-backup.
- Real-time clock with battery-backup.

Security

- Embedded firewall.
- TLS/SSL support with full certificate management.
- TLS/SSL support for SMTP, MQTT, FTP, HTTP, RTCU Communication Hub and TCP/IP sockets.
- Hardware assisted strong encryption/authentication: AES-128, AES-192, AES-256, DES, TripleDES, HASH, RND and RSA signature.

Storage

- Persistent data flash.
- Non-volatile SRAM.
- Internal flash drive (Up-to 512 MByte).
- Circular datalogger.
- Micro SD-card.

Cellular Engine

- LTE Cat.4 Engine (Worldwide).
Max 150 Mbps(DL)/Max 50 Mbps(UL).
LTE FDD: 15 bands.
LTE-TDD: 4 bands.
WCDMA: 7 bands.
GSM: Quad-band.
- DTMF decoding / transmission.
- Digitized voice playback / IVR.
- Internal SIM card-reader, with Mini-SIM 1.8/3 volt.
- Optional eSIM.

Audio

- Fully digitized audio system.
- Transfer, store and play audio.
- Digitized cellular audio.

Wireless LAN

- WiFi at 2,4 GHz ISM bands.
- IEEE 801.11b/g/n/d/e/h/i.
- WPA/WPA2 certification.
- Up-to 150 Mbps.

Bluetooth

- Classic and Low Energy (LE).
- Bluetooth 2.1 + EDR up-to 3 Mbps
- Bluetooth 3.0 and 4.0 Dual mode.
- Intelligent co-existence with WiFi.

ISM RF

- 868 Mhz ISM RF.
- Multiple protocol support.
- Range (depending on environment / antenna):
Up to 50 meter indoor.
Up to 300 meter outdoor.
- Can be disabled for worldwide compliance.

GNSS

- GPS, GLONASS, GALILEO and QZSS.
- Active 3 volt GNSS antenna.
- Antenna and short-circuit detection.

Wired Communication

- 100BASE-T Ethernet interface.
- 2 x RS232. One with control signals.
- 2 x RS485.
- 1-Wire bus.
- USB service/programming port.

User Interaction

- 4 x bi-colour LED.
- DIP-switches.
- I/O configuration jumpers for analog and digital operating modes.
- Jumpers for RS485 termination
- Reset / recovery switch.

Sensors

- Temperature sensor.
- 3-axis Accelerometer. ±16g@16b.

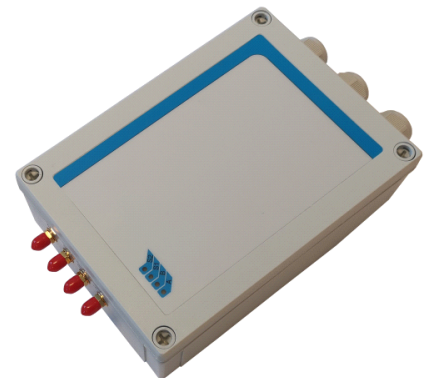

Digital I/O Interface

- 4 x relay output.
Max. 5A @ 250VAC / 30 VDC
- 5 x digital inputs.
Logic high: 8 to 40 VDC.
Logic low: -5 to 3 VDC.
Impedance: 13.8kohm @ 12V.
- 4 x IEC62053-31 Class A input.
- I/O expansion Modbus modules.

Analog I/O Interface

- 4 x analog inputs.
Range is 0..10VDC or 0..20 mA
Resolution: 12 bit
Accuracy: Typ. $\pm 0.3\%$ FSR @ 25°C
Impedance: 40 kohm (V)/504 ohm (C).
- 4 x analog outputs.
Range is 0..10VDC or 0..20 mA
Resolution: 12 bit
Accuracy: Typ. $\pm 0.3\%$ FSR @ 25°C.
- Protected against transients and low-pass filtered.
- I/O expansion Modbus modules.

Electrical

- Supply operating range:
8 to 36 VDC.
100 to 260 VAC.
- Short and reverse power protected.
- 5 V DC-out @ 300 mA.
- 12/24V DC-out @ 500/250 mA.

Battery and Charger

- On-board 2Ah (nominal) Li-Ion battery.
- Intelligent charger with temperature throttle and sub-zero degrees support.
- On-board temperature sensor.

Power Management

- Low-power modes.
- Wait for Event: Timer, Digital input, RS232/RS485, Cellular, Power change.
- Power consumption:
down to 0.35 mA@12V.
- Supervision of supply voltage / type.

Internal Interfaces

- Plug-compatible with the AX9 turbo.
- Micro SD-Card slot with presence detection.
- Mini SIM-card slot.
- Service-port (Mini USB-B).
- RJ45 for LAN with LED indicators.
- Screw-terminals for:
Power, I/O and DCOUT.
- Angled screw-terminals for:
RS232, RS485, 1-Wire and DC-out.
- Jumpers for RS485, I/O and DC-out operating modes.

External Interfaces

- 3 x M20 cable glands.
- SMA female connector for cellular.
- SMA female connector for GNSS.
- SMA female connector for ISM.
- RP-SMA connector for WLAN/Bluetooth.

Physical Characteristics

- Encapsulation:
Durable Polycarbonate plastic.
- TPE gasket.
- Colour: RAL 7035—light grey.
- Approx. 710 gram without accessories.
- W 130 x H 180 x D 60 mm.
[without external connectors.]

Environmental Specification

- Operating temperature: -40 to 60°C.
- Battery charge temperature:
-10 to 45 °C
- Recommended storage temperature:
0 to 45°C.
- Humidity: 5..90% (non condensing).
- Impact resistance: IK08 (EN62262)
- UV resistance: UL 508.
- Flammability Rating: UL746C 5"
- Ingress Protection: IP66 (EN60529).

Approvals

- 2014/53/EU Radio Equipment Directive.
- 2014/30/EU EMC Directive
- 2011/65/EU RoHS Directive.
- Cellular:
GCF/CE/FCC/PTCRB/IC/Anatel/SRRC/NAL/
CCC/KC/NCC/JATE/TELEC/RCM/IFETEL/
FAC/NBTC/ICASA.

Warranty

- Two-years return to factory parts and labor.
- Optional warranty up to 5 years.
[restrictions apply].



Technical data are subject to changes.

*** END OF DOCUMENT ***