

# RTCUNX-400 evo

Advanced Industrial M2M/IoT Gateway



Technical Manual  
Version 1.00

**\* \* \* THIS PAGE IS INTENTIONALLY LEFT BLANK \* \* \***

## Introduction

The **RTCU NX-400 evo** is a powerful M2M/IoT Gateway device that rests on an entirely new hardware and software architecture representing a major leap in functionality, power, openness, and performance. The **RTCU NX-400 evo** has been designed for the most demanding M2M and Internet of Things applications that demand the absolute most advanced product available on the market.

The device is based on the new **NX32L** (NX32 for Linux) architecture, which embraces many new technologies and at the same time maintains full backward compatibility, which ensures already implemented and tested **NX32** applications can execute without changes.

The **RTCU NX-400 evo** device has been designed to meet the ever-increasing security challenges It offers full TLS on all major protocols and includes a hardened protected execution environment with dual-boot and automatic fallback and recovery.

The **RTCU NX-400 evo** device is an industrial DIN rail device that has been designed from the ground up for professional M2M / IoT applications with its strong on-board I/O capabilities and multiple communication interfaces such as: An Worldwide LTE Cellular Engine, WLAN, Bluetooth Classic / Low-Energy, CAN bus, Ethernet, dual RS232, dual RS485, and 1-Wire.

The **RTCU NX-400 evo** also sports a USB host port interface allowing expansion of the device with accessories such as: GPS, RFID reader, additional Ethernet port, and additional RS232/RS485 ports

The on-board I/O system can be expanded almost indefinitely and completely transparently by adding Modbus I/O modules. This unique I/O expansion capability, combined with the ability to operate as a Modbus master and slave simultaneously, positions the **RTCU NX-400 evo** as the perfect product for SCADA-like applications.

This manual contains technical documentation covering the installation and usage of the RTCU NX-400 evo device. For detailed information on the programming and software configuration of the product, please refer to the RTCU IDE documentation.

For detailed information on the powerful RTCU M2M Platform, please refer to the *RTCU M2M Platform datasheet*.

## Table of contents

Introduction.....	3
Important Information.....	6
Technical Highlights .....	7
RTCU NX-400 evo Overview .....	9
Front-side view:.....	10
Bottom-side view:.....	11
Top-side view: .....	11
Power Supply.....	14
Mini USB-B Connector .....	15
Ethernet Connector .....	15
USB Host Port Connector.....	15
Digital Inputs with S0.....	17
S0 compliant inputs ( <i>IEC62053-31, Class A compatible</i> ).....	17
Wakeup (ignition) Input .....	18
Analog Inputs .....	19
Analog Outputs .....	20
Analog Input/Output Mode Selection Switches .....	21
CAN Bus Port .....	23
RS232 Port 1 .....	24
RS232 Port 2 .....	24
RS485 Communication Ports (EIA/TIA-485-A compatible).....	25
RS485 Port 1 .....	25
RS485 port 2 .....	25
1-Wire Bus .....	26
DC-Out.....	26
LCD Display with Touch.....	28
Graphical LCD Display .....	28
Cellular .....	29
Network .....	30
The Clock .....	32
System Menu .....	33
Set Time.....	33
Config .....	33
Jumpers .....	34
Log out.....	34
About.....	34
LED Indicators .....	35
User LED A and B .....	35
System LED S1 and S2 .....	35
DIP and Reset-Switches .....	37
DIP-switch.....	37
System switch (RST).....	37

Battery Backup Power.....	37
Rechargeable Li-Ion Battery.....	37
Lithium Battery.....	38
External Li-Ion Battery (Optional).....	39
Worldwide LTE Cat. 4 Cellular Engine.....	40
WLAN and Bluetooth.....	40
Wi-Fi Technical Data.....	40
Bluetooth Technical Data.....	40
SIM-Card.....	41
Antennas.....	41
LTE Antenna.....	41
WLAN / Bluetooth Antenna.....	41
SD-CARD reader.....	42
Approved SD-Card's.....	42
Product Identification Label with Barcode.....	43
Power consumption.....	44
Appendix A – Removing the Protective Film.....	45
Appendix B – Installing the SD-CARD.....	45
Appendix C – Installing the SIM-Card.....	46
Appendix D - Open Source Disclaimer.....	47
RTCU NX-400 evo Specifications.....	48

## Important Information



Thank you very much for using a product from Logic IO Aps. Our products are designed for professional use and therefore this manual assumes technical knowledge and practice working with such products.

This documentation does not entail any guarantee on the part of Logic IO Aps with respect to technical processes described in the manual or any product characteristics set out in the manual. We do not accept any liability for any printing errors or other inaccuracies in the manual, unless it can be proven, that we are aware of such errors or inaccuracies, or that we are unaware of these as a result of gross negligence and Logic IO Aps has failed to eliminate these errors or inaccuracies for this reason.

This product is a complex and sensitive electronic product. Please act carefully and ensure that only qualified personnel will handle and use the device. In the event of damage to the device caused by failure to observe the information in this manual and on the device, Logic IO Aps shall not be required to honor a warranty claim even during the warranty period and shall be exempted from the statutory accident liability obligation. Any attempts to repair or modify the product also voids all warranty claims. Do not open the product. There are no user-serviceable parts inside.

Please contact Logic IO for any technical or commercial inquiries:

**Logic IO Aps.**  
**Holmboes Alle 14**  
**8700 Horsens**  
**Denmark**  
**Phone: +45 76250210**  
**Support: [support@logicio.com](mailto:support@logicio.com)**  
**URL: [www.logicio.com](http://www.logicio.com)**

## Technical Highlights

### Platform:

- Based on the **RTCU M2M Platform**.
- **NX32L (NX32 for Linux)** execution architecture.
  - RTCU IDE development tool.
  - Operates under a full and highly optimized Linux variant.
  - Open and extendable with Platform SDK.

### Hardware Core:

- Cortex-A5 32-bit ARM processor operating at 500 Mhz.
- Hardware floating point and DSP instructions.
- 128 MByte LP-DDR RAM.
- 512 MByte NAND Flash (file-systems).
- 16 MByte NOR flash (system boot).
- 128 KB SRAM with battery backup (unlimited endurance).
- Real-time clock with battery backup.

### Security:

- Embedded firewall.
- TLS/SSL support with full certificate management.
- TLS/SSL support for all major TCP protocols, such as SMTP, MQTT and sockets.
- Hardware assisted encryption/authentication: AES-128, AES-192, AES-256, DES, TripleDES, HASH, RND and RSA signature.

### Wireless Communication:

- Worldwide LTE Cat.4 Multi-Band Cellular Engine.
- Wireless LAN (Wi-Fi).
- Classic and Low-Energy Bluetooth.
- Optional: Wireless M-Bus, ZigBee and KNX.

### Wired Communication:

- 100 Mbps Ethernet LAN interface.
- Full CAN 2.0B controller with hardware filtering and multi-speed support.
- 1-Wire bus for accessories such as ID-button reader, temperature sensors, etc.
- USB host port for expandability.
- 2 x RS232 channels and 2 x RS485 channels.

### I/O Interfaces:

- 4 x analog inputs and 4 x analog outputs with 0..10 volt / 0..20 mA.
- 8 x digital inputs and 8 x high-power solid-state digital outputs.
- Up to 4 digital inputs can be configured as IEC62053-31 Class A compliant.
- Expandable I/O with standard Modbus modules.

### User Interaction:

- Graphical 240x160 pixels White-on-Blue display.
- Status-bar with information on the state of all interfaces.
- Touch-screen with virtual buttons.
- High-speed Mini-USB service-port connector.

### Audio:

- Fully digitized audio system.
- Transfer, store and play audio.
- Line and amplified speaker output.
- Microphone input.
- Digitized cellular audio.
- DTMF support for Interactive Voice Response applications.

### Storage:

- Internal flash drive with up-to 512 MByte capacity.
- Persistent memory and circular datalogger.
- Standard SD-CARD reader.
- USB flash media.

### Power and Battery:

- Operating voltage from 8 to 36VDC.
- On-board 2Ah Li-Ion battery with intelligent charging.

### Encapsulation:

- Housed in a standard 9M DIN-rail dark-grey enclosure.

### Regulatory Approvals:

- 2014/53/EU, 2014/30/EU and 2011/65/EU.





## RTCU NX-400 evo Overview



All interfaces are conveniently located on the RTCU NX-400 evo product's exterior, and there are no interfaces or user-serviceable parts inside the device.

Most connections to external equipment are found on two-way pluggable terminal blocks located on the top and bottom sides of the RTCU NX-400 evo device.

On the back-side of the device are jumpers for analog mode selection and external battery selection.

The RTCU NX-400 evo uses two-way terminal blocks for maximum flexibility and easy installation. The removable part can detach either by hand or using a suitable tool. To avoid damage to the screws, use an appropriate screwdriver when attaching wires to the terminals.

On the label of the device the layout of the terminal blocks is documented, and all other interfaces are conveniently labeled with their usage.

#### Front-side view:

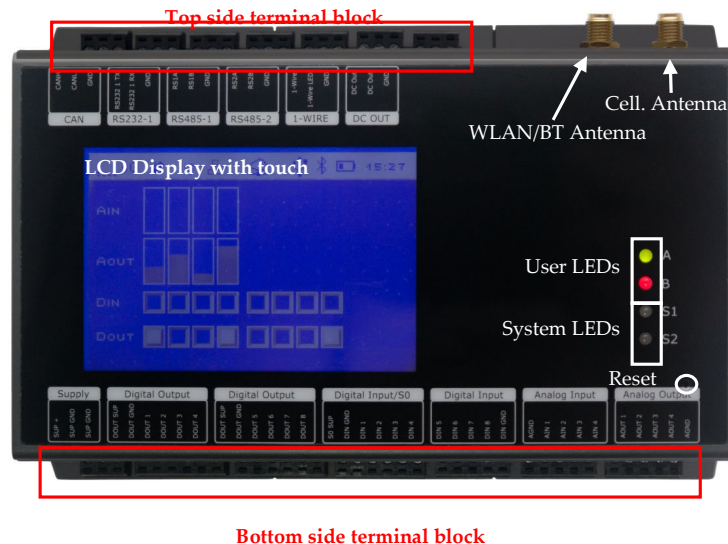

On the front side of the device, a large LCD display with a touch screen is found, that shows a detailed status of the device. Please refer to the section on the *LCD Display with Touch* for detailed information on the LCD display. Also found on the front side of the device are the User and system LEDs and the reset switch.

**Bottom-side view:**

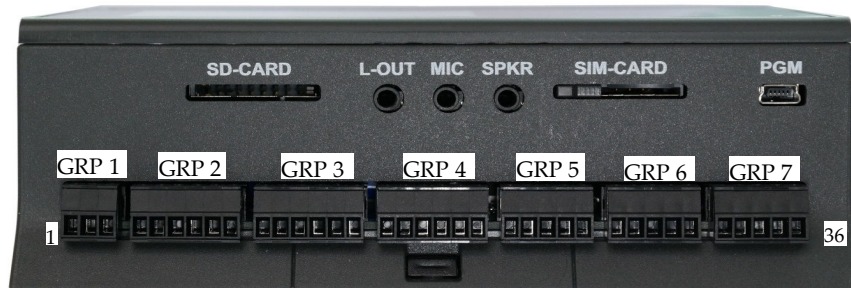

**Bottom terminal block side view**

On the bottom side, terminal blocks for the following interfaces are found:  
Power, digital inputs, digital outputs, analog inputs, and analog outputs.

Above the terminal blocks the following interfaces are found:  
SD-CARD reader, audio jacks, SIM-card reader, and the mini-USB service port.

**Top-side view:**



**Top terminal block side view**

On the top side terminal blocks, the following interfaces are to be found:  
CAN bus, 1-Wire bus, RS485 ports, DC-out, and connection for an optional external battery.

Above the terminal blocks, the following interfaces are found:  
SMA connector for LTE, RP-SMA connector for Wi-Fi / Bluetooth, USB host port, Ethernet connector, RS232 port, and the DIP switches.

## External Interfaces

### Terminal Blocks Signal Overview

#### Pin 1 - 36 overview

Group	Pin	Name	Description
1	1	SUPP	Power supply, positive (+) connection
	2	PGND	Power ground, negative (-) connection
	3	PGND	Power ground, negative (-) connection
2	4	DOUT SUPP	Digital output isolated supply for the digital outputs 1-4
	5	DOUT GND	Digital output isolated ground for the digital outputs 1-4
	6	DOUT1	Digital Output 1
	7	DOUT2	Digital Output 2
	8	DOUT3	Digital Output 3
3	9	DOUT4	Digital Output 4
	10	DOUT SUPP	Digital output isolated supply for the digital outputs 5-8
	11	DOUT GND	Digital output isolated ground for the digital outputs 5-8
	12	DOUT5	Digital Output 5
	13	DOUT6	Digital Output 6
4	14	DOUT7	Digital Output 7
	15	DOUT8	Digital Output 8
	16	S0 SUPP	S0 circuit isolated supply, positive (+) terminal
	17	DIN GND 1	S0/digital input isolated ground / negative (-) terminal
5	18	DIN1	Digital input 1 / S0 input 1 / Wake-up ( <i>ignition</i> ) input
	19	DIN2	Digital input 2 / S0 input 2
	20	DIN3	Digital input 3 / S0 input 3
	21	DIN4	Digital input 4 / S0 input 4
6	22	DIN5	Digital input 5
	23	DIN6	Digital input 6
	24	DIN7	Digital input 7
	25	DIN8	Digital input 8
7	26	DIN GND 2	Digital input isolated ground
	27	AGND	Analog ground
	28	AIN 1	Analog input 1
	29	AIN 2	Analog input 2
	30	AIN 3	Analog input 3
8	31	AIN 4	Analog input 4
	32	AOUT 1	Analog output 1
	33	AOUT2	Analog output 2
	34	AOUT3	Analog output 3
	35	AOUT4	Analog output 4
	36	AGND	Analog ground

**Pin 37 - 57 overview**

Group	Pin	Name	Description
8	37	CAN-H	CAN-bus H-signal
	38	CAN-L	CAN-Bus L-signal
	39	SGND	Signal ground
9	40	UART1_TXD	Transmit data from serial port 1, RS232 compatible
	41	UART1_RXD	Receive data for serial port 1, RS232 compatible
	42	SGND	Signal ground
10	43	RS485_1+	RS485 non-inverting signal for RS485 port 1
	44	RS485_1-	RS485 inverting signal for RS485 port 1
	45	SGND	Signal ground
11	46	RS485_2+	RS485 non-inverting signal for RS485 port 2
	47	RS485_2-	RS485 inverting signal for RS485 port 2
	48	SGND	Signal ground
12	49	1WIRE	1-Wire bus for accessories such as ID-button/temperature sensors
	50	1WIRE-LED	1-Wire ID-button LED
	51	SGND	Signal ground
13	52	DCOUT	+5V / 300mA DC-OUT for external equipment (tied together internally)
	53	DCOUT	+5V / 300mA DC-OUT for external equipment (tied together internally)
	54	SGND	Signal ground
14	55	XBAT+	External battery positive (+) connection
	56	GND	External battery negative (-) connection
	57	XBAT NTC	External battery NTC temperature sensor connection

*Note: The Group 14 connector is not supplied with the device.*

## Power Supply

The RTCU NX-400 evo device must be supplied with 8..36 VDC from an external DC power source. Positive power is applied to the SUP+ pin, and ground is connected to the SUP GND pin.

There are five different ground labels for ground connections:

- 1) Supply Ground (SUP GND)
- 2) Signal Ground (GND)
- 3) Analog Ground (AGND)
- 4) Digital Input Ground (DIN GND)
- 5) Digital Output Ground (DOUT GND).

The signal and analog grounds are filtered from the power ground. The analog ground is used as a low-noise analog ground reference for the analog inputs and outputs. Power ground must only be used as a power supply return path. The digital input ground is optically isolated from the system ground. The digital input ground is also group-wise optically isolated from each other on different terminal groups.

The RTCU NX-400 evo is protected against wrong polarity. If a chassis or system ground is connected to either GND or AGND, a wrong polarity on the supply lines will destroy the internal GND connection.

The RTCU NX-400 evo contains an internal high-capacity backup battery, which will supply the RTCU if the external power supply fails or is disconnected. By default, the RTCU is powered down, when a power failure occurs. This setting, however, can be changed. Please consult the RTCU IDE on-line help for more information. When the wakeup/ignition inputs are activated with a logical high, the RTCU NX-400 evo device will wakeup if it was in power-down mode.

### Please Note:

- A minimum 14 VDC supply is necessary for 0-10V analog output configuration.

### Power supply pins

Group	Pin	Name	Description
1	1	SUP +	Power supply, positive (+) connection
	2	SUP GND	Power ground, negative (-) connection
	3	SUP GND	Power ground, negative (-) connection



### **Mini USB-B Connector**

This USB port is for programming and communication with the RTCU IDE (RACP compliant application). A standard USB cable can be used between the device and the PC.

### **Ethernet Connector**

This is a standard 10Base-T/100Base-TX IEEE 802.3 compliant RJ45 Ethernet connector. Please use an appropriate connector and cable, such as a standard CAT-5 twisted pair patch cable

### **USB Host Port Connector**

This is a standard full-speed USB-A host port connector used for communication with accessories connected to the host port. This port is supplied internally, and current consumption is limited to 500mA.

Accessories that can be connected to the USB Host port include: RFID reader, GPS receiver, additional LAN port, additional RS232/RS485 ports, Camera, and industrial USB hubs.

## Digital Outputs

The digital outputs control eight "high-side" switches. They function like a contact, where one side is connected to the positive supply of the RTCU device, and the other is the output. The switches are protected against short circuit, ESD and electronic kickback from inductive loads such as relays etc. The maximum switchable inductance is 20mH and must not be exceeded.

The digital outputs are supplied from the DOUT SUP+ and DOUT GND power pins for each group independent of the system supply. Digital outputs are isolated from the system and from each digital output group. With this design, it is entirely possible and fully supported that the digital outputs operate on one voltage supply and the device on another voltage supply.

The RTCU NX-400 evo device offers power management, which makes it possible to have one or more outputs enabled while the RTCU is in low-power mode. Please consult the RTCU IDE on-line help for more information.

### Digital output pins

Group	Pin	Name	Description	
P	4	DOUT SUP	Digital output supply, positive (+) connection	
	5	DOUT GND	Digital output ground, negative (-) connection	
	2	6	DOUT1	Digital output 1
		7	DOUT2	Digital output 2
8		DOUT3	Digital output 3	
9		DOUT4	Digital output 4	
3	10	DOUT SUP	Digital output supply, positive (+) connection	
	11	DOUT GND	Digital output ground, negative (-) connection	
	12	DOUT5	Digital output 5	
	13	DOUT6	Digital output 6	
	14	DOUT7	Digital output 7	
	15	DOUT8	Digital output 8	

### Specification for each digital output

Type	Min.	Max.	Unit	
Solid state	5.5	36	VDC	Short-circuit, Overload, Overvoltage, ESD,
	-	1.5	A	Inductive kickback protected up to 20mH (single pulse).
	-	280	mΩ	On-state resistor per channel



## Digital Inputs with S0

The eight digital inputs are all low-pass filtered (105 kHz) and transient-protected. The digital inputs are divided into two groups. Digital input 1-4 can be configured as S0 input (IEC62053-31, Class A) by supplying the S0 circuit through the S0 SUP and DIN GND 1 terminal pins and enabling the S0 interface through the user application. When not supplied, the inputs act as normal digital inputs. The digital inputs 5-8 are normal digital inputs. To activate the normal digital inputs, connect a positive voltage between the corresponding input (DINx) and DIN GND on the corresponding terminal connector group.

The digital input 1 can act as wakeup input sources.

### S0 compliant inputs (IEC62053-31, Class A compatible)

In the S0 configuration mode, the relevant RTCU NX-400 evo input will act as a 'pulse input device,' and a current is supplied into the input connector so that a simple switch between DIN GND 1 and the appropriate input will activate it. This is used in most electricity metering equipment.

**Please note:** The S0 auxiliary supply input located on the terminal group 4 must be supplied with a minimum of 16 VDC for the S0 mode to work according to IEC62053-31, Class A.

S0 must also be enabled from the application to work as an S0 compliant input.

DIN GND 1 and DIN GND 2 are isolated and **not** tied together internally.

### Wakeup (ignition) Input

The DIN1 is a special input that also functions as the wakeup input. If the input is activated with a logical high or low (Wait For Event mode only), when the RTCU NX-400 evo is in low-power mode, it will wakeup the device. A power apply will also wake the device up if it is in power-down mode or in Wait For Event mode with Power Apply and/or ignition selected for wakeup. The input is de-bounced with a period of 1 ms, when used as wakeup source in power-down mode. So, any logical level applied to this input must be greater than 1 ms to be valid.

The power management allows for the possibility of configuring a wakeup on one or more digital inputs with individually configured falling- or rising edge detection. Please consult the RTCU IDE on-line help for more information.

### Digital input pins

Group	Pin	Name	Description	Condition
	16	S0 SUP	S0 auxiliary supply	
	17	DIN GND 1	Digital input / S0 ground	
	18	DIN1 / S0IN1	S0 input 1 Digital input 1	S0 supply applied and enabled Wake-up (ignition)
4	19	DIN2 / S0IN2	S0 input 2 Digital input 2	S0 supply applied and enabled
	20	DIN3 / S0IN3	S0 input 3 Digital input 3	S0 supply applied and enabled
	21	DIN4 / S0IN4	S0 input 4 Digital input 4	S0 supply applied and enabled
	22	DIN5	Digital input 5	
	23	DIN6	Digital input 6	
5	24	DIN7	Digital input 7	
	25	DIN8	Digital input 8	
	26	DIN GND 2	Digital input ground	

### Specification for each digital input

	Min.	Typ.	Max.	Unit	
Logic "High"	8	12	40	VDC	Protected against transients and low-pass filtered
Logic "Low"	-5	-	3	VDC	
Cut-off frequency	-	105	-	kHz	
Bandwidth (standard)		12		kHz	@12V
Bandwidth (S0)		3		kHz	
Input impedance	-	3.3	-	kΩ	@ 12V

## Analog Inputs

The RTCUI NX-400 evo device has four analog inputs, which can be configured individually to work as voltage or current measurement inputs by using the configuration dipswitch, located on the back-side of the device. The range in voltage mode is 0-10 VDC, and in current mode it is 0-20 mA. The conversion resolution is 12-bit.

By default the analog inputs are configured as voltage input, and are converted to a digital value with a resolution of 12-bit before being presented to the application (0..4095). Please consult the RTCUI IDE for further details.

The input signal is connected between AINx and AGND. AGND must be connected to the reference of the connected equipment. Please be aware that deviations may occur, as the system is very noise sensitive. Avoid long, unshielded wires, and high current fast-changing signals routed parallel to the analog signals.

### Analog input pins

Group	Pin	Name	Description	Dip-switch state
	27	AGND	Analog ground	
	28	AIN1	Analog input 1 – Voltage Analog input 1 – Current	Dip-switch 1 is off ( <i>default</i> ) Dip-switch 1 is on
6	29	AIN2	Analog input 2 – Voltage Analog input 2 – Current	Dip-switch 2 is off ( <i>default</i> ) Dip-switch 2 is on
	30	AIN3	Analog input 3 – Voltage Analog input 3 – Current	Dip-switch 3 is off ( <i>default</i> ) Dip-switch 3 is on
	31	AIN4	Analog input 4 – Voltage Analog input 4 – Current	Dip-switch 4 is off ( <i>default</i> ) Dip-switch 4 is on

### Specification for each analog input (voltage mode)

	Min.	Typ.	Max.	Unit	
Resolution	0	-	10	VDC	Protected against transients and low-pass filtered
Accuracy	-	0.3	0.5	%FSR	The accuracy is based on measurements @ 25 °C
Cut-off frequency	-	4.5	-	kHz	
Input impedance	-	40	-	kΩ	

### Specification for each analog input (current mode)

	Min.	Typ.	Max.	Unit	
Resolution	0	-	20	mA	Protected against transients and low-pass filtered
Accuracy	-	0.3	0.5	%FSR	The accuracy is based on measurements @ 25 °C
Cut-off frequency	-	4.5	-	kHz	
Input impedance	-	500	-	Ω	

## Analog Outputs

The analog outputs are individually configurable to work either as voltage or current outputs. The range in voltage mode is 0-10 VDC, and in current mode, it is 0-20 mA. The resolution of the digital-to-analog converter is 12 bit or 4096 in decimal scale. The decimal value for 10V/20mA output is 4095 and 2047 for 5V/10mA.

As default, the outputs are configured as voltage outputs. The dipswitch that configures the analog output as voltage or current is located at the back-side of the device.

The output signal is connected to external equipment between AOUTx and AGND. AGND must be connected to the reference of the connected equipment. Please be aware that deviations may occur, as the system is very noise sensitive. Avoid long unshielded wires, and large, fast-changing signals routed parallel to the analog signals. In current mode the specifications for the analog output are only valid if the maximum load is **250Ω**.

**Please note:** The RTCU NX-400 evo device must be supplied with a minimum of 14 VDC for the analog outputs to work according to specifications.

### Analog output pins

Group	Pin	Name	Description	Dipswitch position
	32	AOUT1	Analog output 1 – Voltage	Position 1 ( <i>default</i> )
			Analog output 1 – Current	Position 2
	33	AOUT2	Analog output 2 – Voltage	Position 1 ( <i>default</i> )
			Analog output 2 – Current	Position 2
7	34	AOUT3	Analog output 3 – Voltage	Position 1 ( <i>default</i> )
			Analog output 3 – Current	Position 2
	35	AOUT4	Analog output 4 – Voltage	Position 1 ( <i>default</i> )
			Analog output 4 – Current	Position 2
	36	AGND	Analog ground	

### Specification for each analog output (voltage mode)

	Min.	Typ.	Max.	Unit	
	0	-	10	VDC	Protected against transients The accuracy is based on measurements @ 25 °C
Resolution	-	-	12	Bit	
Accuracy	-	0.3	0.5	%FSR	
Load	500	-	-	Ω	

### Specification for each analog output (current mode)

	Min.	Typ.	Max.	Unit	
	0	-	20	mA	Protected against transients The accuracy is based on measurements @ 25 °C
Resolution	-	-	12	Bit	
Accuracy	-	0.3	0.5	%FSR	
Load	-	-	250	Ω	

## Analog Input/Output Mode Selection Switches

The analog input and outputs can be operated in two modes: Voltage or Current mode. The mode for each individual analog input/output can be selected with dedicated DIP-switches, that is located on the back-side of the RTCU NX-400 evo device.

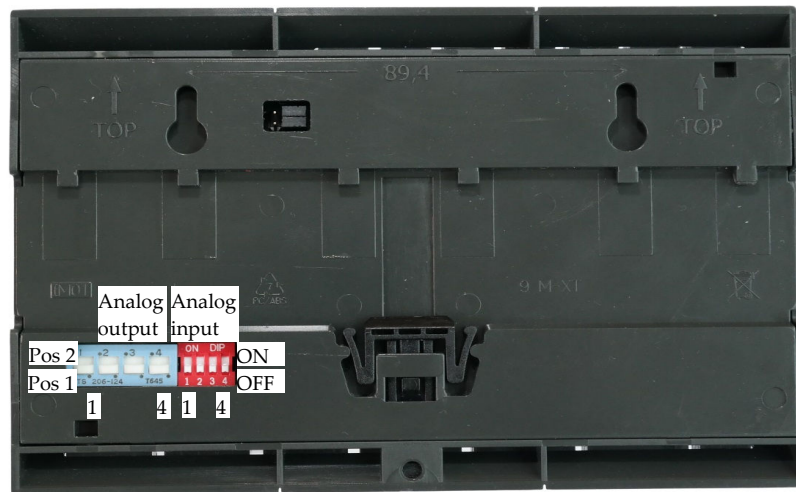

There is a "blue" DIP-switch block for selecting the mode of the analog outputs, and equally there is a "red" DIP-switch block for selecting the mode for the analog inputs.

### Analog output switch:

Pin	Position	Function
1	Pos 1	Analog output 1 voltage output
	Pos 2	Analog output 1 current output
2	Pos 1	Analog output 2 voltage output
	Pos 2	Analog output 2 current output
3	Pos 1	Analog output 3 voltage output
	Pos 2	Analog output 3 current output
4	Pos 1	Analog output 4 voltage output
	Pos 2	Analog output 4 current output

**Analog output switch:**

Pin	Position	Function
1	ON	Analog input 1 as current input
	OFF	Analog input 1 as voltage input
2	ON	Analog input 2 as current input
	OFF	Analog input 2 as voltage input
3	ON	Analog input 3 as current input
	OFF	Analog input 3 as voltage input
4	ON	Analog input 4 as current input
	OFF	Analog input 4 as voltage input

## CAN Bus Port

The RTCU provides the physical layer for the CAN (Controller Area Network) serial communication interface in accordance with the ISO 11898 standard. The CAN bus is designed for high-speed (up to 1Mbit) robust communication in especially harsh environments like those found in the automotive industry.

The CAN interface can be connected to an existing CAN network with a common protocol like the J1939 standard to retrieve information for surveillance or information purposes. The interface can also be used as a robust serial data link with a non-standard protocol. Please consult the RTCU IDE documentation for more information.

The physical layer consists of a two wire (CAN-H and CAN-L) differential bus and a signal ground for reference.

If the RTCU is connected to a "non-existing" network, a 120<sup>1</sup> ohm resistor must be connected between CAN-H and CAN-L on each end of the transmission line in order to terminate it and avoid signal reflections. This resistor can be connected by activating the software jumper in the user application or in the system menu of the display. Please consult the RTCU IDE document for the software jumper, and the display section in this document for detailed description on the system menu.

Be aware that connecting the RTCU to a CAN network can be dangerous. If the RTCU is not configured with the correct network parameters, it will lead to network corruption and may interfere with other connected equipment on the bus. Especially in vehicles great precautions must be observed to prevent communication interruptions.

By default the write capability on the CAN bus is enabled. This can be disabled by software jumper in the user application or in the system menu of the display.

A wide range of software functions is available for easy access to the network. Please consult the RTCU IDE documentation for further information.

### CAN pins.

Group	Pin	Name	Description
8	37	CAN-H	CAN-bus H-signal
	38	CAN-L	CAN-bus L-signal
	39	GND	Signal ground

<sup>1</sup> Assuming use of a CAT5 twisted pair cable

### RS232 Port 1

This port can be used as a general-purpose RS232 serial port and does not support any hardware handshaking.

#### RS232 port 1 pins

Group	Pin	Name	Description
9	40	RS232 1 TX	Transmit data from serial port 1, RS232 compatible
	41	RS232 1 RX	Receive data for serial port 1, RS232 compatible
	42	GND	Signal ground

### RS232 Port 2

The port is a general-purpose RS232 port with all control signals according to EIA-561 which defines RS232 on a modular connector.

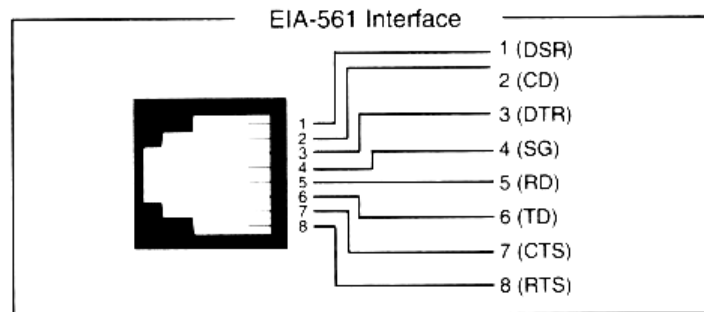

The signals are available on the RJ-45 connector located on the top side of the RTCU NX-400 evo device.

#### SER2 connector overview, fully RS232-compatible (RJ-45)

Pin	Name	Description
1	DSR	Data Set Ready
2	DCD	Data Carrier Detect
3	DTR	Data Terminal Ready
4	GND	Signal Ground
5	RD	Receive Data for serial port 2
6	TD	Transmit Data from serial port 2
7	CTS	Clear To Send
8	RTS	Request To Send



## RS485 Communication Ports (EIA/TIA-485-A compatible)

RS485 is a multi-drop network with a maximum of 32 nodes connected simultaneously to the bus. The RS485 bus contains an RS485+ (also known as RS485 A, non-inverting) and an RS485- (also known as RS485 B, inverting) signal as well as a signal ground, which must always be connected to the common signal ground for all nodes connected to the RS485 bus!

The maximum cable length for the RS485 bus is according to the EIA/TIA-485-A standard (max. 1000m @ <100kbit); this limit is highly influenced by the cable quality and signaling rate, noise etc.

At longer cable lengths, noisy environments, or high communication speeds, it might be necessary to terminate the transmission line with a 120<sup>1</sup> ohm resistor at each end of the transmission line to terminate it and avoid signal reflections. If the RTCU NX-400 evo is used as an endpoint node, the software jumper for both RS485 ports separately can be activated through the user application or in the system menu of the display in order to terminate the RS485 communication lines with 120Ω.

By default, the RS485 communication lines are not terminated with 120 Ω. Please consult the RTCU IDE documentation for further information on how to use the software jumpers and the LCD display section in this document for using the system menu.

**Please note:** For best performance, protection and noise immunity shielded cable advised to be used to connect the device to RS485 communications bus.

### RS485 Port 1

#### RS485 port 1 pins

Group	Pin	Name	Description
10	43	RS1A	RS485 non-inverting signal for RS485 port 1
	44	RS1B	RS485 inverting signal for RS485 port 1
	45	GND	Signal ground

### RS485 port 2

#### RS485 port 2 pins

Group	Pin	Name	Description
11	46	RS2A	RS485 non-inverting signal for RS485 port 2
	47	RS2B	RS485 inverting signal for RS485 port 2
	48	SGND	Signal ground

<sup>1</sup> Assuming use of a CAT5 twisted pair cable

## 1-Wire Bus

All 1-Wire communication goes through a single connection, and all 1-Wire devices connected to this connection retrieve their power directly from the bus (called parasitic power). For this only two wires are needed – the 1-wire signal and the ground reference – allowing minimal cable installations.

For 1-Wire ID-Button readers, which include a built-in LED, a dedicated output is available for this purpose. Please consult the RTCU IDE documentation for further information.

For further information regarding the modular 1-wire concept, please refer to the document "Modular 1-Wire Concept Technical Manual" on the Logic IO webpage.

### 1-Wire pins

Group	Pin	Name	Description
12	49	1-Wire	1-Wire bus for communication
	50	1-Wire LED	1-Wire ID-Button LED
	51	GND	Signal ground

## DC-Out

A 5 VDC output is available to power external equipment. It is possible to control the output in order to save power. The output is short circuit- (to ground), ESD- and transient protected. Make sure not to exceed the current specification of the output and be aware that in-rush currents of the external equipment may exceed the specifications. It is recommended to install a fuse to protect the output.

This output must be enabled from the application. Please consult the RTCU IDE on-line manual for more information.

Please note that the two DC Out pins are tied together internally, and the limitation of 300mA is the total consumption on both pins.

### Connector X1: 6-pin SER1 connector overview

Group	Pin	Name	Description
13	52	DC Out	+5V / 300 mA DC-OUT for external equipment.
	53	DC Out	+5V / 300 mA DC-OUT for external equipment.
	54	GND	Signal ground

## Audio Interface

The audio interface is available on the three 3.5mm jack connectors on the bottom side of the device. The audio interface includes a line output, microphone input, and speaker output.



### Connector SPK Out

Pin	Name	Description
Tip	SPK_OUT_P	Differential speaker positive (+) output
Ring	SPK_OUT_N	Differential speaker negative (-) output
Sleeve	N.A.	Not connected internally

### Connector Mic In

Pin	Name	Description
Tip	MIC_BIAS	Bias voltage to the microphone
Ring	MIC_IN	Audio signal from the microphone
Sleeve	GND	Signal ground

### Connector Line Out

Pin	Name	Description
Tip	LINE_OUTL	Line output left channel
Ring	LINE_OUTR	Line output right channel
Sleeve	GND	Signal ground

The specifications on the audio interface connectors are as following:

Parameter	Min.	Typ.	Max.	Unit	Description
Impedance	4	-	-	$\Omega$	
Output power	-	-	2.1	W	@ 4 ohm 50pF load
	-	-	1.4	W	@ 8 ohm 50pF load
Headphone impedance	16	-	-	$\Omega$	AC coupled
Full-scale input voltage	-	-	0.74	V <sub>rms</sub>	
Stereo line-out impedance	-	10	-	K $\Omega$	
Stereo line-out full-scale voltage	-	0.67	-	V <sub>rms</sub>	
Mic. bias voltage	-	2.5	-	V	$\pm 10\%$

## LCD Display with Touch

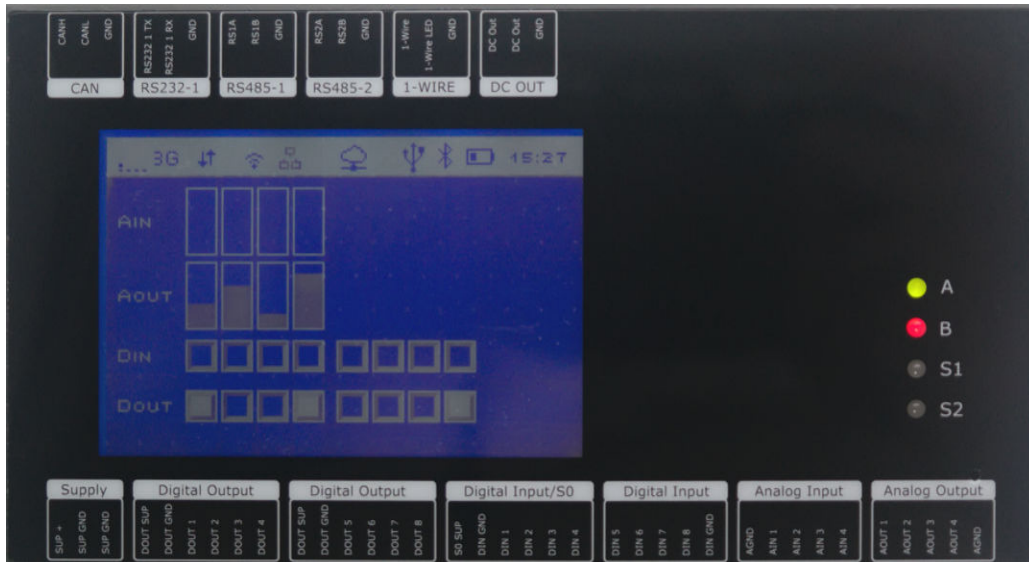

### Graphical LCD Display

The display mounted on the RTCU NX-400 evo is a 240x160 pixel white on blue graphical display with built-in resistive touch sensing.

A range of display functions is available for making graphical and alpha-numerical presentations of the data, user interaction with menus etc. The display is fully backward compatible with previous applications using the onboard LCD Display.

By default, the display is powered on at startup and shows I/O status, battery status and the status of many of the communication interfaces, as shown in the following picture:

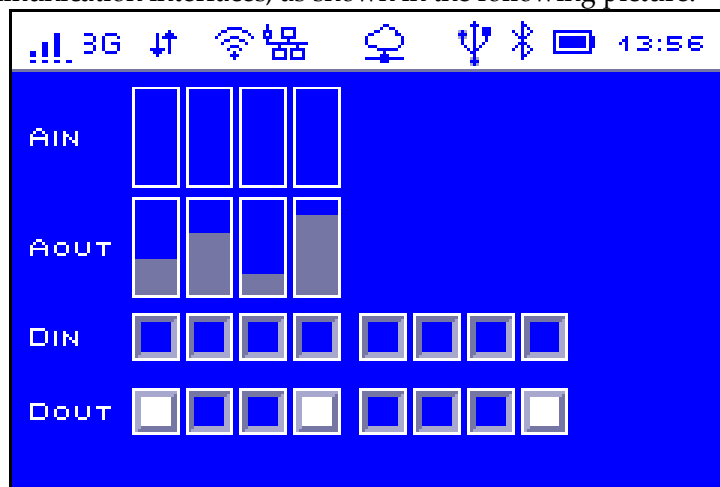

In the main part of the display, the status of the different inputs and outputs are shown.

On the top, the analog inputs and outputs use bar graphs to show the current value.

Below the analog values, the digital inputs and outputs are shown in groups of 4.



The top 20 pixels are reserved for the status bar, which shows the status of the different communication interfaces as well as the time and the battery status. The status bar provides access to monitoring and configuring the device.

Clicking on an icon on the status bar can show a dialog with more detailed information, if it is enabled in the configuration dialog or with the SOS setting `gui.status.details_allowed`.



The icons on the status bar from left to right are:

### Cellular

#### Cellular Status



Status	Icon
Cellular off	
Cellular on	
Signal strength	

#### Cellular network type

Status	Icon
2G	
3G	
4G	

Clicking either cellular status or cellular network status may show a dialog with details about the connection, including signal strength and the provider PLMN.

**Mobile network status**

Status	Icon
Network connected	
Roaming	
Network connected while roaming	

Clicking this icon may show a dialog with the status of the network connection, including IP



**Call status**

Status	Icon
Call active	

Clicking this may show the cellular status dialog.



**Network**

**WLAN Status**

Status	Icon
WLAN Off	
WLAN on	
WLAN signal level	



Clicking this icon may show a dialog with the Wi-Fi details, including SSID, IP address and signal strength.

**LAN 1 status & LAN 2 status**

Status	Icon
LAN off	
LAN on	
LAN connected	

Clicking this icon may show a dialog with the LAN details, including IP address.

### RTCU Communication Hub status

Status	Icon
RTCU Communication Hub not enabled	
RTCU Communication Hub enabled	
RTCU Communication Hub connected.	



Clicking this icon may show a dialog with the RCH details, including the name of the RCH and the used interface.

### USB status

Status	Icon
USB host supported	

Clicking this icon may show a dialog with the USB details, including the status of the host port and the USB programming cable.

### Bluetooth status

Status	Icon
Bluetooth off	
Bluetooth on	

Clicking this does not currently do anything.

### Power status

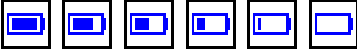
Status	Icon
Battery level	

The battery level is indicated with five levels; the fully filled battery icon means fully charged, and the empty battery icon means low battery level. While charging the battery the battery icon is animated to show all the levels with a one second delay.

Clicking the battery icon may show a dialog showing the power status, including the battery level, supply type, and temperature.

### The Clock

The clock shows the current time on the RTCU and can be used to access the system menu. In addition to the IO status, the main part of the display can also be used for custom drawing using the display API or for powerful GUI applications using the GUI API.

The display functions are fully supported and use on-screen touch buttons for user input, with the remaining area providing space for 6 rows of 23 characters.



Using the GUI functions, it is possible to create custom forms with a number of different controls, taking full advantage of the touch screen for creating intuitive user interaction.

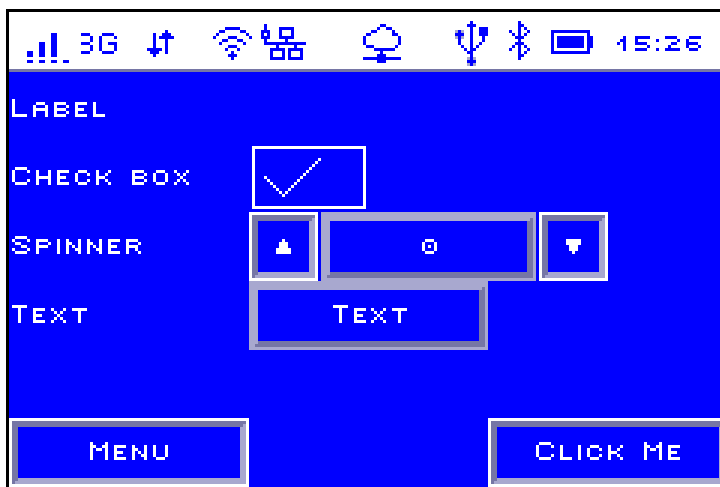



## System Menu

The system menu can be used to configure some properties of the device.

To use the system menu, it must be enabled, either via the IDE or with the guiSysMenu functions.

By default, the system menu is enabled, using the password "RTCUI".

To access the system menu, press the clock icon on the status bar for more than 1 second and release.

A dialog now appears requesting the password. Note, that the password is case sensitive, and that the keyboard defaults to lower case letters.

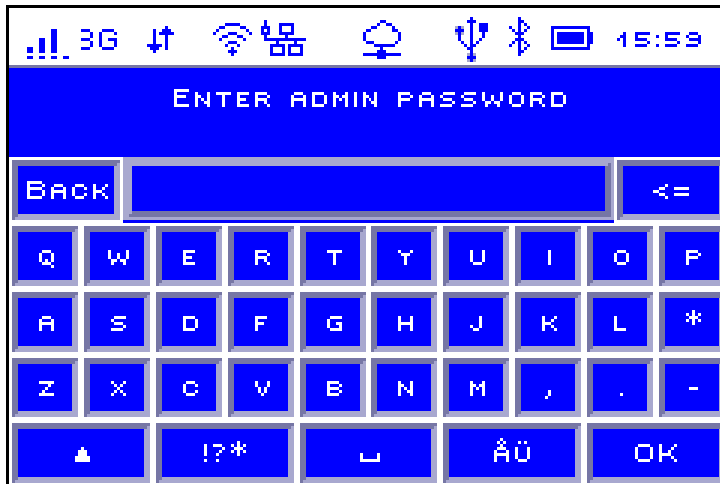

Once the password has been entered successfully, the clock changes color, and by clicking it, the system menu is shown.

The system menu contains the following items:

### Set Time

Shows a dialog to show and change the time in the device.

### Config

Shows the configuration dialog, which can be used to configure some settings.



- Show details without login.
  - Provides read-only access to the system menu and the details on the status icons.
- Admin timeout
  - The number of seconds of inactivity before the system menu logs out automatically. Set to 0 to disable automatic logout.
- Run on battery
  - Controls if the device continues to operate on the battery when external power is removed.

### Jumpers

Shows a dialog for configuring the virtual jumpers in the device.

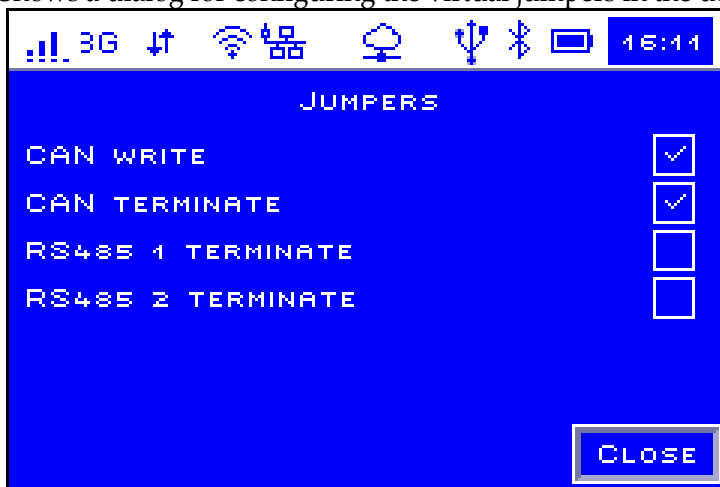

The jumpers are applied when the dialog is closed.

### Log out

Logs out of the system menu.

### About

Shows an about dialog, showing information about the system.

## LED Indicators

Four bi-colored (red and green) and a single yellow LED indicator are present on the front of the device (see graphical overview).

Two bi-colored LEDs (A and B) are available to the user and the remaining two LEDs (S1 and S2) are signaling the status and possible errors of the RTCU device.

### User LED A and B

LED A and B are composed of four individually controllable LEDs:

- LED named A on the front consists of LED 1 (green) and LED 2 (red).
- LED named B on the front consists of LED 3 (green) and LED 4 (red).

They are easily accessed from within the application program, and it is possible to mix the LEDs to obtain a third color: yellow. Please consult the RTCU IDE documentation for more information.

### System LED S1 and S2

The RTCU is equipped with two system LEDs, which shows the status and possible errors of the RTCU device.

The different patterns are listed in the table below. If the color of the system LED S1 is yellow, the device is actively communicating with the RTCU IDE (or another program supporting the RTCU RACP protocol).

The LED S2 is signaling either the cellular module activity, or if all other LEDs are off that the RTCU is in the "wait for event" low power state.

### S1: System LED1 pattern overview

Pattern	Description
Fastest blinking, green	The device is initializing, preparing to start the application.
Fast blinking, green S2 On, green	The device is installing an update. Depending on the kind of update, it may take some time. The progress can also be observed on the display.
Fast blinking, green <sup>1</sup>	The device has been forced into recovery mode with the system switch. The application is not executing.
500ms On / 500ms Off green <sup>1</sup>	The device is executing the application program
1.5s On / 0.5s Off. green <sup>1</sup>	The device executes the application program while charging the internal backup battery.
Fast blinking, red <sup>1</sup>	A runtime error has been detected in the program. Use the RTCU IDE to obtain the fault log.
Alternating Fast/Slow, red <sup>1</sup>	The device has lost its firmware. This can only happen if, during a firmware upgrade, the RTCU device loses power or the communication is lost completely. In this case, simply upload the firmware to the device again.
75ms On / 925ms Off, green	Execution speed is different from full speed.
On yellow (All other Leds OFF)	The device is booting, initializing the system

### S2: System LED2 pattern overview (Cellular activity and "Wait For Event")

Pattern	Operating Status
Off	The cellular engine is turned off
600 ms On / 600 ms Off green	Missing SIM card or PIN code. Network search and logon in progress.
75 ms On / 3 s Off green	Logged on to the network.
75 ms On / 75 ms Off / 75 ms On / 3 s OFF green	A GPRS/Data packet session is active.
Flashing green	Indicates data transfer.
On green	A voice session is active.
On green (and all other LEDs OFF)	The system is booting.
On yellow (and all other LEDs OFF)	The system is booting into recovery mode.
On red (and all other LEDs OFF)	The system is booting into monitor mode.
10 s OFF / 50 ms ON green (and all other LEDs OFF)	The RTCU device is in a low-power "Wait For Event" state.

<sup>1</sup> Or yellow when communicating with the RTCU IDE or another program, supporting the RTCU RACP protocol).

## DIP and Reset-Switches

### DIP-switch

The RTCU NX-400 evo device contains four DIPswitches, three of which are available for the application to use (*the fourth dipswitch is reserved for future use*).

The dip switches are located on the top side of the device for easy user access (see graphical overview).

### System switch (RST)

The RTCU NX-400 evo device contains a combined reset/diagnostic switch. This switch is accessible from the front of the unit (see graphical overview) It is necessary to use a small thin object with a diameter of approx. 2 mm, for example, a straightened-out paper clip for this purpose.

By activating the switch shortly, the RTCU device will do a complete reset, as if the power was removed and reapplied.

If the reset switch is held down for approx. 3 seconds<sup>1</sup>, the device will instead enter recovery mode<sup>2</sup>, and the application will not be started. In recovery mode, the system will automatically turn on the cellular engine to establish a connection to the network and RTCU Communication Hub (if configured).

Pressing reset will also activate the device when in power-down mode. If external power is removed and the backup battery is disabled, the reset switch can still be used to boot into recovery mode, as long as enough power is left on the battery.

## Battery Backup Power

### Rechargeable Li-Ion Battery

The RTCU contains an internal Li-Ion battery for operation even, when the external power is absent, making it possible to report power loss etc. Please note that when external power is removed, the device will be powered down by default. This setting can be changed as documented in the RTCU IDE documentation.

The analog outputs will be disabled when a power failure occurs as the internal battery cannot provide the supply voltage needed.

The battery charging is completely automated and handled internally by the RTCU device – leaving no need for user interaction. Different kinds of functions (Battery low, Charger enable, Charging status, etc.) are available to the user application.

---

<sup>1</sup> System LED S2 will flash green three times when this state is entered.

<sup>2</sup> System LED S1 will indicate this state by fast blinking green or yellow.

The charge current is relatively high, for a shorter charge time, as specified in the technical specification. Make sure the power supply and cables can handle the high current.

The battery will be charged, whenever a power failure has occurred to establish the capacity, thus making the battery ready for the next power failure.

By default, the battery cannot be charged above 45°C or below 0°C. The RTCU offers charging down to -10 °C using a specialized algorithm to protect the battery.

If the temperature is above 45°C, the charging will not start and will be postponed, until it is below this threshold.

The temperature has a very high influence on the battery capacity. At 0°C the capacity has dropped to 60% of the initial capacity, and it falls dramatically at lower temperatures.

The battery cycle (numbers of charges and discharges) also influences the capacity. After 300 cycles, the capacity has dropped to approximately 80% of the initial capacity.

### **Warning**

*Misusing the RTCU device may cause the built-in battery security circuit to be damaged.*

- *Do not place the RTCU device in high-temperature locations such as in direct sunlight or near engines. Using the RTCU device in this environment may result in a loss of battery performance and a shortened life expectancy.*
- *Do not expose the device to water, salt water or allow the battery to get wet.*
- *Avoid strong impacts and shocks.*

For more information regarding the environmental limitations, see "Specifications for RTCU NX-400 evo" below or consult the RTCU NX-400 evo datasheet.

### **Lithium Battery**

The RTCU NX-400 evo has an onboard Lithium coin-cell type battery that in case of total power loss, powers the SRAM (used by the persistent memory FRAM API) and the real-time clock of the device.

Power from the Lithium coin-cell battery is only drawn, when there is no external power present and the rechargeable Li-Ion battery is fully exhausted. The expected lifetime of the Lithium coin cell in this state is 6+ years.

### External Li-Ion Battery (Optional)

External battery connection is possible on the terminal block connectors on the top side. Jumpers located on the back side of the device is used to switch between the internal and external battery.

**Please note:** Only Lithium-Ion batteries (3.7V nominal) are allowed as an external battery, and both battery switching jumpers (jumper 1 and jumper 2) must be moved together. Mixing the jumpers in different positions may cause abnormal operation, and in worst case damage the battery/device.

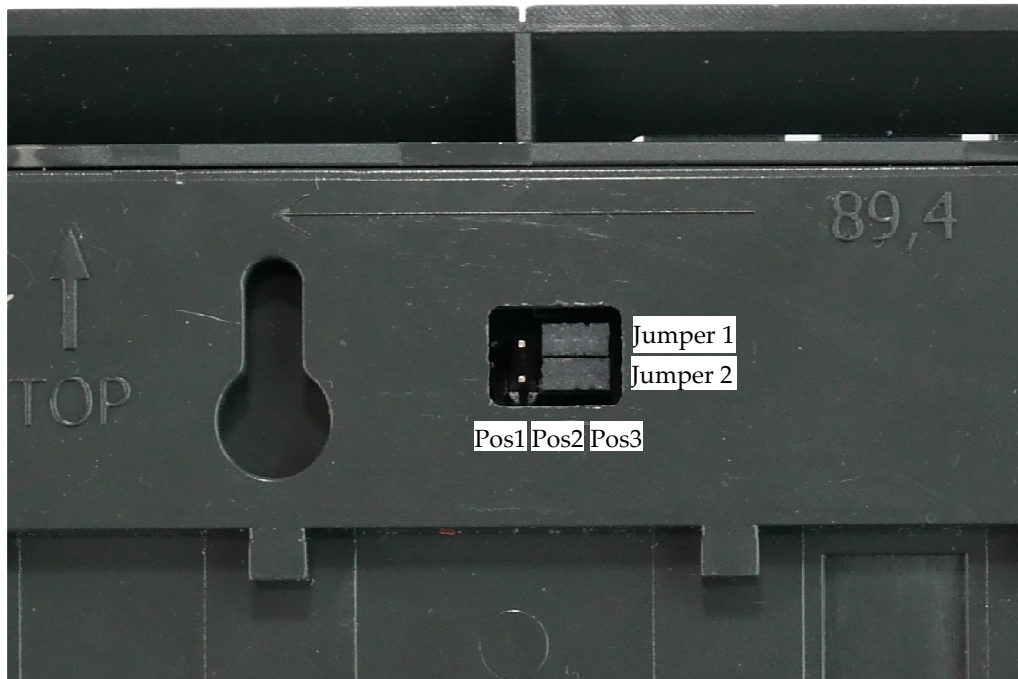

### Battery selection jumpers

Jumper	Position	Used battery
1	1-2	External battery (NTC temperature sensor)
	2-3	Internal battery (NTC temperature sensor, default)
2	1-2	External battery (positive (+) terminal)
	2-3	Internal battery (positive (+) terminal, default)

**Please note:** The jumper pins are exposed when not covered by the jumper. When mounting the device in the installation, ensure that the jumper pins don't touch any metal surfaces. Covering the battery selection jumper opening after installation/selection of the desired battery is advised.

## Worldwide LTE Cat. 4 Cellular Engine

The RTCU NX-400 evo uses an LTE/UMTS/HSPA engine with the following features:

- Max. 150Mbps down / 50Mbps upload (Cat 4)
- LTE-FDD: B1/ B2/ B3/ B4/ B5/ B7/ B8/ B12/ B13/ B18/ B19/ B20/ B25/ B26/ B28.
- LTE-TDD: B38/ B39/ B40/ B41
- WCDMA: B1/ B2/ B4/ B5/ B6/ B8/ B19
- GSM: 850/900/1800/1900 MHz
- SMS (Text and PDU)
- UMTS release 7, max. 42Mbps down / 5.76Mbps upload, (Cat 6)
- Digitized audio / DTMF capability.

## WLAN and Bluetooth

The RTCU NX-400 evo device contains a combined Wi-Fi and Dual-mode Bluetooth radio that shares the same antenna interface.

### Wi-Fi Technical Data

- Wi-Fi at 2.4 GHz ISM bands.
- IEEE 801.11b/g/n/d/e/h/i.
- WPA/WPA2 certification.
- Up-to 150 Mbps.

### Bluetooth Technical Data

- Classic and Low-Energy (LE) Bluetooth.
- Bluetooth 2.1 + EDR up-to 3 Mbps.
- Bluetooth 3.0 and 4.0 Dual-mode.
- Intelligence co-existence with Wi-Fi.



## SIM-Card

The RTCU NX-400 evo device contains a standard mini-SIM card reader which is located on the bottom side of the unit (see graphical overview) for ease of access. The SIM card reader has a push/push eject system and a mechanical lock for secure installation of the SIM card. Please refer to Appendix A for a SIM card installation guide.

It is possible to detect the state of both the SIM Insert and SIM lock status from the application. Please consult the RTCU-IDE on-line manual for more information.

If the SIM card is removed during the cellular operation, the device will be rejected from the network shortly after.

## Antennas

### LTE Antenna

The RTCU NX-400 evo device contains an SMA female connector for connecting a suitable LTE antenna. When installing the antenna, please make sure that the antenna is not near metallic parts or anything else which can influence the antenna's efficiency. Please consult the installation guide that follows the antenna.

### WLAN / Bluetooth Antenna

The RTCU NX-400 evo device contains an RP-SMA connector for connecting a suitable Wi-Fi / Bluetooth antenna. The Wi-Fi and Bluetooth communication circuit shares the same antenna, so only one single antenna is required. When installing the antenna, please make sure that the antenna is not near metallic parts or anything else which can influence the antenna's efficiency. Please consult the installation guide that follows the antenna.

## SD-CARD reader

The RTCU NX-400 evo device has a standard SD-CARD reader which is located on the bottom side of the device (see graphical overview) The RTCU NX-400 evo supports a FAT file-system for standard PC compatibility with up to 32 GB capacity support.

The SD-CARD features a push/push eject system for reliable insertion and operation. Please refer to Appendix B for an SD-Card installation guide.

### Approved SD-Card's

*To ensure the highest performance and compatibility it is important to use SD-Card's that has been approved and tested by Logic IO.*

Commercial grade SD-Cards can be used in applications where the limited write endurance is acceptable - for example, if the SD-CARD is often replaced. Commercial grade SD-Card's should **not** be used in applications where a potential failure on the media is considered mission-critical.

For applications that uses the SD-CARD media extensively and where a failure is critical, it is recommended to use approved **Industrial Grade** SD-Card's.

Logic IO has approved and recommends industrial-grade SD-Card's from **ATP** that is available in capacities from 512 MB to 32 GB.

ATP Industrial Grade SD/SDHC Cards are optimized for demanding industrial applications with consistent performance in all conditions. ATP uses reliable SLC flash technology with a flash endurance more than 20 times higher than commercial grade products with MLC flash.

The differences in write endurance between commercial-grade MLC flash and ATP Industrial grade SLC flash is quite remarkable for write-intensive applications:

Product Line	Details	Total Writeable Data Prediction @ 1GB	Time Prediction @ 500 writes a day (1GB)
ATP Industrial Grade	SLC Flash	80,000GB	<b>5,740 days</b>
	+ Advanced Wear Leveling	or 2,800,000 writes	or <b>15.7 years</b>
Commercial Grade	Grade A MLC (2 bits per cell)	4,000GB	<b>280 days</b>
	+ Advanced Wear Leveling	or 140,000 writes	

## Product Identification Label with Barcode

The RTCU NX-400 evo product identification is found on the exterior of the device and contains a unique serial-number in readable form and as a barcode.

The first three digits in the serial-number identify the device type, and for the RTCU NX-400 evo this unique code is **315**.

**Barcode format used:** 2/5 Interleaved with check-digit.

## Power consumption

Detailed information on the maximum power consumption of the RTCU NX-400 evo device in different states and supply voltages is listed below.

### Maximum power consumption: Device operating from external supply

	8V	12V	36V	
Device active	152	103	36	mA
Device active with cellular on*	194	130	46	mA cellular idle @ -63dBm* (2G)
Device active with GPRS session*	375	250	88	mA cellular @ -65dBm, LCD off, Battery not charging*
Device active with LCD on	160	109	39	mA
Device active while charging	1020	650	232	mA
Device in power-down	1.7	1.1	0.53	mA Restart on DIN1, RTC
Device in "wait for event"	7.4	4.6	1.8	mA Resume on DIN, RTC
Device in "wait for event"	16	10	4	mA Resume on CAN

If the external power source is removed and the internal battery is enabled the power consumption from the battery will be as listed below.

### Maximum power consumption: Device operating from internal battery

	BAT	
Device active	275	mA
Device active with Cellular on	360	mA Cellular idle @ -63dBm
Device active with GPRS session*	865	mA Cellular @ -65dBm, LCD off,
Device active with LCD on	290	mA
Device in power-down	2.5	mA Restart on DIN1, RTC
Device in "wait for event"	11.5	mA Resume on DIN, RTC
Device in "wait for event"	85	mA Resume on CAN

**Note:** Power consumption from the battery @ 3.8V

**Note:** Values marked with (\*) are averaged and should be considered as guidelines as they may vary depending on the cellular signal strength.

## Appendix A – Removing the Protective Film

The RTCUNX-400 evo device is delivered with a thin, almost invisible transparent protective film on the front label. To ensure the LCD-display's best visibility, remove this film before using the device.

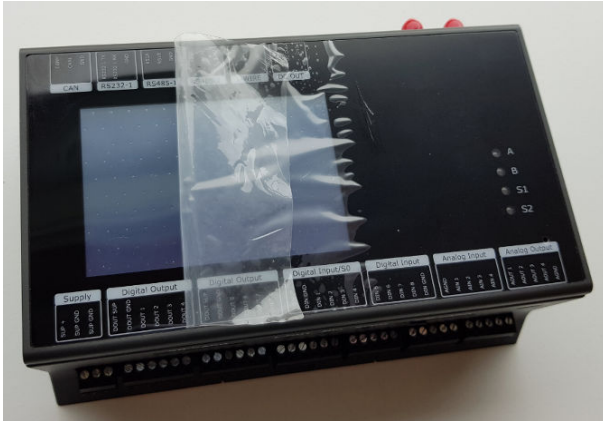

The protective film is removed by firmly removing it, as shown above.

## Appendix B – Installing the SD-CARD

To insert a card into the reader, orientate it as shown below and push the card into the reader until a click sound occurs. Then, remove the card by pushing it into the reader until it clicks, and the reader will eject the card. Avoid removing the SD-CARD during access to the card.

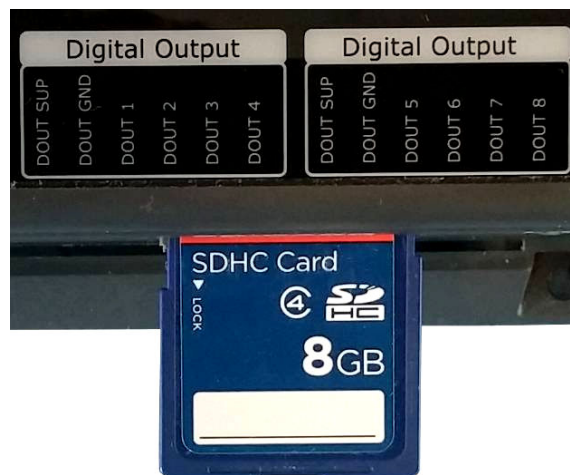

**SD-CARD orientation**

## Appendix C – Installing the SIM-Card

The external accessible SIM card reader has a push/push eject system and a mechanical lock for secure installation of the SIM card.

Orientate the card as shown below and insert it into the card reader. Push the card into the reader until a click sound occurs – the card will now stay in its position. It might be necessary to use a small tool or pencil as the card is placed underneath the enclosure surface for protection purposes. Furthermore, a mechanical slide lock can be used to prevent it from being removed accidentally.

To remove the card, slide the lock to its unlocked position and push the card into the reader until a slight click sound occurs. The reader will now eject the card. Using a small tool or pencil might be necessary to push the card into the reader.

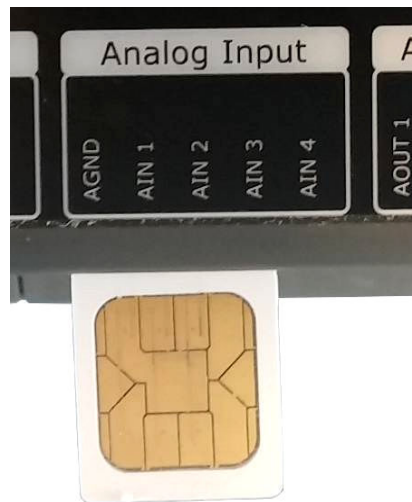

**SIM card orientation**

## Appendix D - Open Source Disclaimer

The RTCU NX-400 evo products include several open-source software tools. This open-source software is governed by the terms and conditions of the applicable open source license, and you are bound by the terms and conditions of the applicable open source license in connection with your use and distribution of the open-source software in this product.

Please refer to the separate document "**RTCU Open Source Licenses.pdf**" for detailed information about the packages used in the RTCU NX-400 evo product.

## RTCU NX-400 evo Specifications

### RTCU M2M Platform

- NX32 for Linux - NX32L.
- Fully NX32 compatible.
- Larger capacity and higher performance compared to NX32.
- Open and user-extendable API\*.
- RTCU M2M Platform SDK.

### NX32L Hardware Core

- Cortex-A5 32-bit ARM processor.
- Hardware floating point and DSP.
- 128 MByte LP-DDR RAM.
- 512 MByte NAND flash.
- 16 MByte NOR flash.
- 128 KByte SRAM with battery-backup.
- Real-time clock with battery-backup.

### Security

- Embedded firewall.
- TLS/SSL support with full certificate management.
- TLS/SSL support for SMTP, MQTT, FTP, HTTP, RCH, and TCP/IP sockets.
- Hardware assisted strong encryption/authentication: AES-128, AES-192, AES-256, DES, TripleDES, HASH, RND and RSA signature.

### Storage

- Persistent data flash.
- Non-volatile SRAM.
- Internal flash drive (Up-to 512 MByte).
- Circular datalogger.
- SD-CARD.
- USB flash media.

### Cellular Engine

- **Multi-band LTE Cat. 4 (Worldwide)**  
LTE FDD: 15 bands.  
LTE-TDD: 4 bands.  
WCDMA: 7 bands.  
GSM: Quad-band.
- DTMF decoding / transmission.
- Digitized voice playback / IVR.
- External Mini SIM card-reader.
- Optional eSIM.

### Wireless LAN

- WiFi at 2,4 GHz ISM bands.
- IEEE 801.11b/g/n/d/e/h/i.
- WPA/WPA2 certification.
- Up-to 150 Mbps.

### Bluetooth

- Classic and Low Energy (LE).
- Bluetooth 2.1 + EDR up-to 3 Mbps
- Bluetooth 3.0 and 4.0 Dual mode.
- Intelligent co-existence with WiFi.

### Optional Wireless

- Wireless M-Bus.
- ZigBee / IEEE 802.15.4.
- KNX RF.

### Audio

- Fully digitized audio system.
- Transfer, store and play audio.
- Line and amplified speaker output.
- Microphone input.
- Digitized GSM audio.

### Wired Communication

- 100BASE-T Ethernet interface.
- Full CAN2.0B with hardware filtering and multi-speed support.
- 2 x RS232. One with control signals.
- 2 x RS485.
- 1-Wire bus.
- USB host port.
- USB service/programming port.

### User Interaction

- Dot-matrix LCD with 240x160 pixels.
- White-on-blue back-lit.
- Status-bar with information on all interfaces.
- Fully programmable with high-level functionality such as graphs, buttons, dialogs etc.
- Touch screen with virtual buttons.
- DX4i pro compatibility mode.
- 4 x bi-colour LED.
- DIP-switches.
- I/O configuration jumpers for analog mode.
- Virtual jumpers for RS485 and CAN termination
- Reset / recovery switch.





### Digital I/O Interface

- 8 x digital solid-state digital output.  
Max. 36 volt / 1.5 A per. channel.  
Short-circuit, ESD, Inductive kick-back protected up to 20 mH.  
User supplied power.
- 8 x digital inputs.  
Logic high: 8 to 40 VDC.  
Logic low: -5 to 3 VDC.  
Impedance: 3.3kohm @ 12V.
- 4 x IEC62053-31 Class A input.
- Digital input #1 can be used as ignition.

### Analog I/O Interface

- 4 x analog inputs.  
Range is 0..10VDC or 0..20 mA  
Resolution: 12 bit  
Accuracy: Typ.  $\pm 0.3\%$  FSR @ 25°C  
Impedance: 40 kohm (V)/504 ohm (C).
- 4 x analog outputs.  
Range is 0..10VDC or 0..20 mA  
Resolution: 12 bit  
Accuracy: Typ.  $\pm 0.3\%$  FSR @ 25°C.
- Protected against transients and low-pass filtered.

### Electrical

- Operating voltage: 8 to 36 VDC.
- Short and reverse power protected.
- 5 VDC-out @ 300 mA.
- USB 5 VDC @ 500 mA.

### Battery and Charger

- On-board 2Ah (nominal) Li-Ion battery.
- Intelligent charger with temperature throttle and sub-zero degrees support.
- Integrated battery temperature sensor.
- Support for larger external battery.

### Power Management

- Low-power modes.
- Wait for Event: Timer, Digital input, Touch screen, RS232\*, CAN, GSM\*, Power change state.
- Wait for event, from: 2 mA@12V.
- Supervision of supply voltage / type.

### External Interfaces

- SD-CARD slot with presence and write protect detection.
- Audio line-Out. 3.5mm mini-jack.
- Speaker-Out. 3.5mm mini-jack.
- Microphone. 3.5mm mini-jack.
- SIM-card slot for mini-SIM with lock and presence detection.
- Service-port (Mini USB-B).
- RJ45 for RS232 [EIA-561].
- RJ45 for LAN with LED indicators.
- USB host-port [USB-A receptable].
- SMA female connector for UMTS.
- RP-SMA connector for Wi-Fi/Bluetooth.
- Pluggable terminal blocks with 3.5 mm pitch and M2 screw:  
Supply, I/O, CAN, RS485, RS232, 1-wire, DC-Out and external battery.

### Expandable

- I/O expansion Modbus modules.
- GPS receiver.
- Additional Ethernet port.
- Additional RS232 / RS485 ports.
- Industrial USB hub.
- Camera with HD video streaming\*
- Speaker and microphone.
- External battery pack.

### Physical Characteristics

- Encapsulation: 9M DIN-rail [EN60715]
- Colour: Dark-Grey.
- Material: Self-extinguishing blend PC/ABS.
- Approx. 465 gram without accessories.
- W 160.2 x H 89 (top) x D53.5 mm.  
(without connectors and terminal blocks).

### Environmental Specification

- Operating temperature: -30 to 60°C.
- Battery charge temperature:  
-10 to 45 °C
- Recommended storage temperature:  
0 to 45°C.
- Humidity: 5..90% (non condensing).
- Ingress Protection: IP20 .

### Approvals

- 2014/53/EU Radio Equipment Directive.
- 2014/30/EU EMC Directive
- 2011/65/EU RoHS Directive.

### Warranty

- Two-years return to factory parts and labor.
- Optional warranty up to 5 years.  
(restrictions apply).



Technical data are subject to changes.



\*\*\* END OF DOCUMENT \*\*\*