

# RTCU LX4 pro

*Advanced Industrial M2M/IoT Gateway*



## Introduction

The **RTCU LX4 pro** is a powerful successor to the **RTCU DX4i pro** with significant improvements in features, capacity, power, and security. In addition, the **RTCU LX4 pro** is based on the latest **LX hardware architecture**, offering an unprecedented balance between price and performance.

The **RTCU LX4 pro** is positioned for a broad range of professional industrial Internet of Things applications. With onboard **M-Bus / Wireless M-Bus** and pulse counting inputs (**S0**), it is a perfect component in advanced **Energy Management** applications.

The device rests on the **NX32L** (NX32 for Linux) architecture that embraces many new technologies and at the same time maintains full backward compatibility, which ensures already implemented and tested **NX32** applications can execute without changes.

The **RTCU LX4 pro** device has been designed to meet the ever-increasing security challenges. It offers full TLS on all major protocols and includes a hardened protected execution environment with dual-boot and automatic fallback and recovery.

The **RTCU LX4 pro** can also operate as a secure and intelligent industrial router/firewall for LAN side clients connecting to the Internet over the cellular interface.

This manual contains technical documentation covering the installation and usage of the **RTCU LX4 pro** device. For detailed information on the product's programming and software configuration, please refer to the RTCU IDE documentation.

For detailed information on the powerful RTCU M2M Platform, please refer to the *RTCU M2M Platform datasheet*.

## Table of contents

Introduction .....	2
Important Information.....	4
Technical Highlights .....	5
RTCU LX4 pro Overview .....	7
Signal Overview .....	10
Mini USB-B Connector.....	12
Ethernet / LAN.....	12
Power Supply .....	12
Digital outputs .....	13
Digital Inputs / S0 inputs / Ignition Input.....	14
S0 compliant inputs (IEC62053-31, Class A compatible) .....	14
Analog Inputs .....	16
Analog Outputs .....	17
RS232 port.....	18
RS485 Port.....	18
RS485 port 1.....	19
RS485 port 2.....	19
1-Wire bus .....	19
Wired M-Bus .....	20
Wireless M-Bus (optional).....	20
User interface .....	21
Graphical LCD display .....	21
Keypad.....	23
System Menu.....	23
LED Indicators .....	25
User LED A and B .....	25
System LED S1 and S2 .....	25
Switches .....	27
DIP-switch.....	27
System switch (RST).....	27
Rechargeable Li-Ion Backup Battery.....	28
LTE Worldwide Cat. 4 Cellular Engine .....	29
SIM-Card .....	29
Antennas.....	29
Cellular Antenna .....	29
Wireless M-Bus Antenna (optional) .....	29
SD-CARD reader .....	30
Approved SD-CARDS.....	30
Product Identification Label with Barcode .....	31
Power Consumption .....	32
Appendices.....	33
Appendix A – Device configuration guide.....	33
Appendix B – Installing the SIM-Card .....	36
Appendix C - Open Source Disclaimer .....	37
RTCU LX4 pro Specifications .....	38

## Important Information



Thank you very much for using a product from Logic IO Aps. Our products are designed for professional use, and therefore this manual assumes technical knowledge and practice working with such products.

This documentation does not entail any guarantee on the part of Logic IO Aps with respect to technical processes described in the manual or any product characteristics set out in the manual. We do not accept any liability for any printing errors or other inaccuracies in the manual, unless it can be proven, that we are aware of such errors or inaccuracies, or that we are unaware of these as a result of gross negligence and Logic IO Aps has failed to eliminate these errors or inaccuracies for this reason.

This product is a complex and sensitive electronic product. Please act carefully and ensure that only qualified personnel will handle and use the device. In the event of damage to the device caused by failure to observe the information in this manual and on the device, Logic IO Aps shall not be required to honor a warranty claim even during the warranty period and shall be exempted from the statutory accident liability obligation. Any attempts to repair or modify the product also voids all warranty claims. Do not open the product. There is no user-serviceable part inside.

Please contact Logic IO for any technical or commercial inquiries:

**Logic IO Aps.**  
**Holmboes Alle 14**  
**8700 Horsens**  
**Denmark**  
**Phone: +45 76250210**  
**Support: [support@logicio.com](mailto:support@logicio.com)**  
**URL: [www.logicio.com](http://www.logicio.com)**

## Technical Highlights

### Platform:

- Based on the **RTCU M2M Platform**.
- **NX32L (NX32 for Linux)** execution architecture.
  - RTCU IDE development tool.
  - Operates under a full and highly optimized Linux variant.
  - Open and extendable with Platform SDK.

### LX Hardware Core:

- Cortex-A7 32-bit ARM processor operating at up to 1 GHz.
- Cortex-M4 32-bit co-processor for advanced power management.
- Hardware floating-point and DSP instructions.
- 128 MByte RAM.
- 512 MByte NAND Flash (system boot, persistent memory, and file-systems).
- Real-time clock with a dedicated backup battery.

### Security:

- Embedded firewall.
- Port forward and NAT services.
- TLS/SSL support with full certificate management.
- TLS/SSL supporting all significant TCP protocols, such as RCH, FTP, SMTP, MQTT, and sockets.
- Hardware-assisted encryption/authentication: AES-128, AES-192, AES-256, DES, TripleDES, HASH, RND and RSA signature.

### Wireless Communication:

- **LTE Cat. 4 Worldwide Multi-Band Cellular Engine**.
- Internal SIM-card reader with support for eSIM.
- **Optional: Wireless M-Bus**. EN 13757-4/7 OMS EU/CE.

### Wired Communication:

- 100 Mbps Ethernet LAN interface.
- **Wired M-Bus** interface with up to 20 slaves.
- **1-Wire bus** for accessories such as ID-button reader, temperature sensors, etc.
- 1 x **RS232** interface with handshake support.
- 2 x **RS485** interface.

### I/O Interfaces:

- 8 x **digital inputs**, up to 4 digital inputs configurable as **IEC62053-31 CLASS A** compliant.
- 8 x high-power **solid-state digital outputs**.
- 4 x **analog inputs with 0..10 volt / 0..20 mA** with 12 bit precision.
- 2 x **analog outputs with 0..10 volt / 0..20 mA**
- **Expandable I/O** with standard Modbus modules.

### Sensors:

- Temperature sensor.

### User Interaction:

- Graphical 144x32 pixels **display**.
- **Keypad with 8 keys** for sophisticated user interaction and control.
- 3 x bi-color, 1 x single color LED.
- High-speed Mini-USB service-port connector.

### Audio:

- Fully digitized audio system.
- Transfer, store, and play audio.
- Digitized cellular audio.
- DTMF support for Interactive Voice Response applications.

### Storage:

- **Internal flash drive** with up to 64 MByte capacity.
- **Persistent memory** and circular datalogger.
- **Standard SD-Card** reader.

### Power and Battery:

- Operating voltage from 8 to 36VDC.
- On-board **2 Ah Li-Ion battery** with intelligent charging.

### Encapsulation:

- Housed in an industry-standard M36 DIN compliant encapsulation.
- Two-part pluggable connectors for easy installation and maintenance.

### Regulatory Approvals:

- Radio Equipment Directive, RED 2014/53/EU.
- EMC Directive, 2014/30/EU.
- 2011/65/EU RoHS Directive.

## RTCU LX4 pro Overview

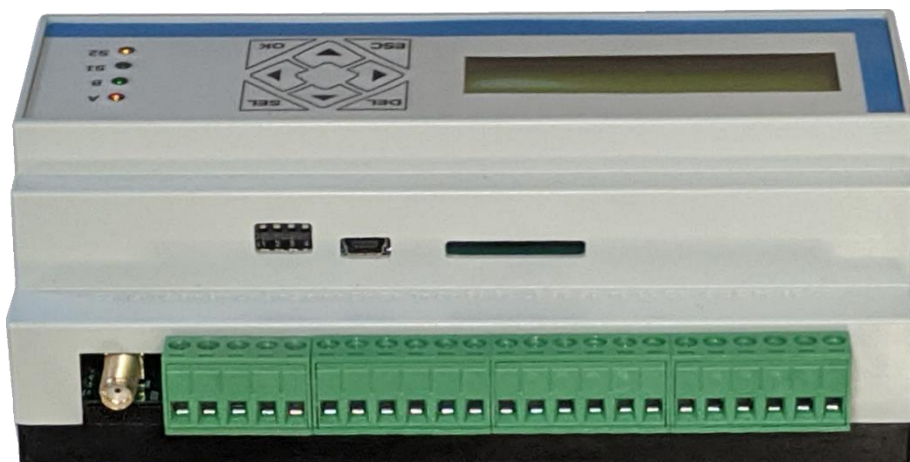

The user interface can be found on the front and consists of a 144x32 easy-to-read graphical LCD, a keypad with eight keys, four user-controlled LEDs, and three system LEDs.

The graphical LCD can show information to the user with both text and graphics fully supported. In addition, the LCD also has icons for battery level/charging-in-progress and network status. The keypad can let the user interact with the LX4 pro and access the system menu.

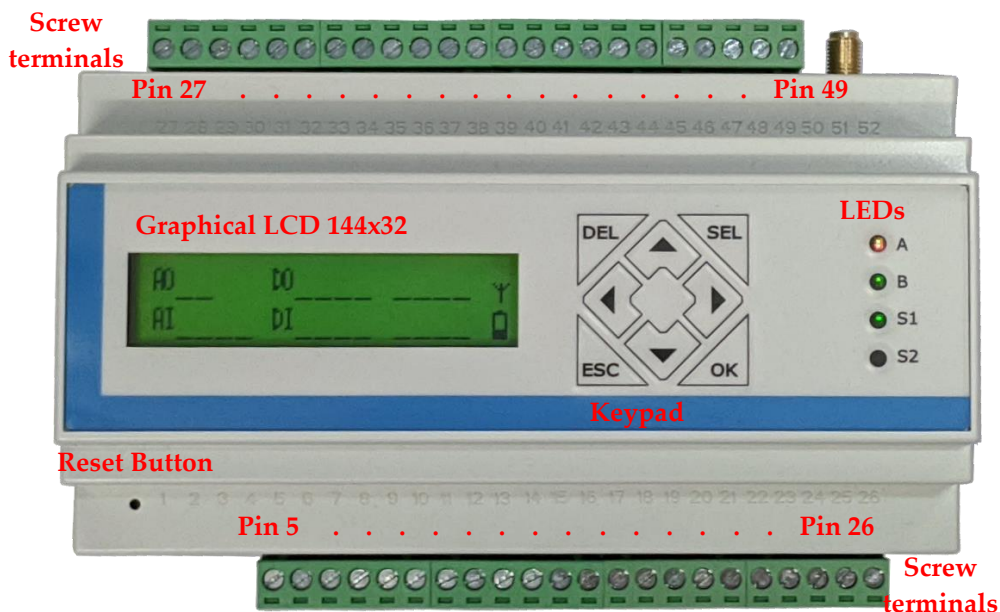

Front-side view

The pluggable screw terminals on the top and bottom sides of the LX4 pro are used to make connections to external equipment.

All the connectors are available externally for easy access and maintenance.

The bottom side of the RTCU LX4 pro has connectors for the following communication interfaces: Ethernet, 1-Wire, RS232, RS485 Port 1 and Port 2, and wired M-Bus. The analog inputs/outputs are also found on this side.

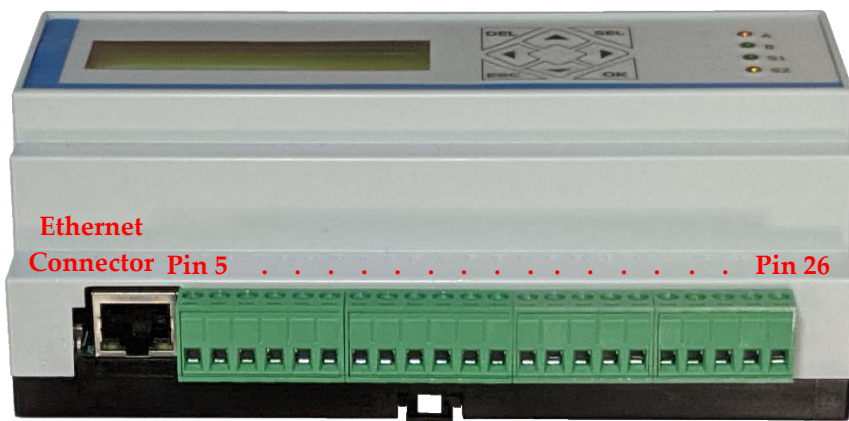

Bottom-side view



The top side of the RTCU LX4 pro has connectors for power, digital inputs, digital outputs, and an SMA female connector for an external cellular antenna.

The SD-card reader, four DIP switches, and the mini-B USB connector used as a programming/service interface are also found on this side.

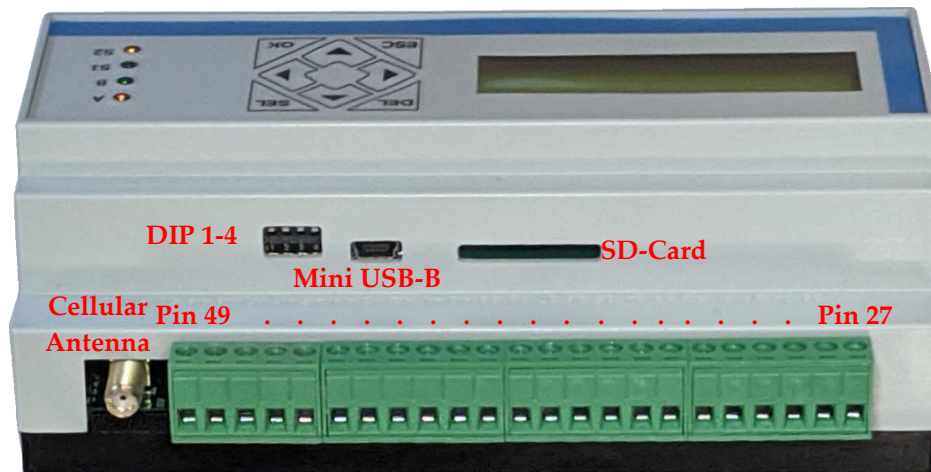

Inside the encapsulation, the SIM card and various configuration/termination jumpers are located.

## Signal Overview

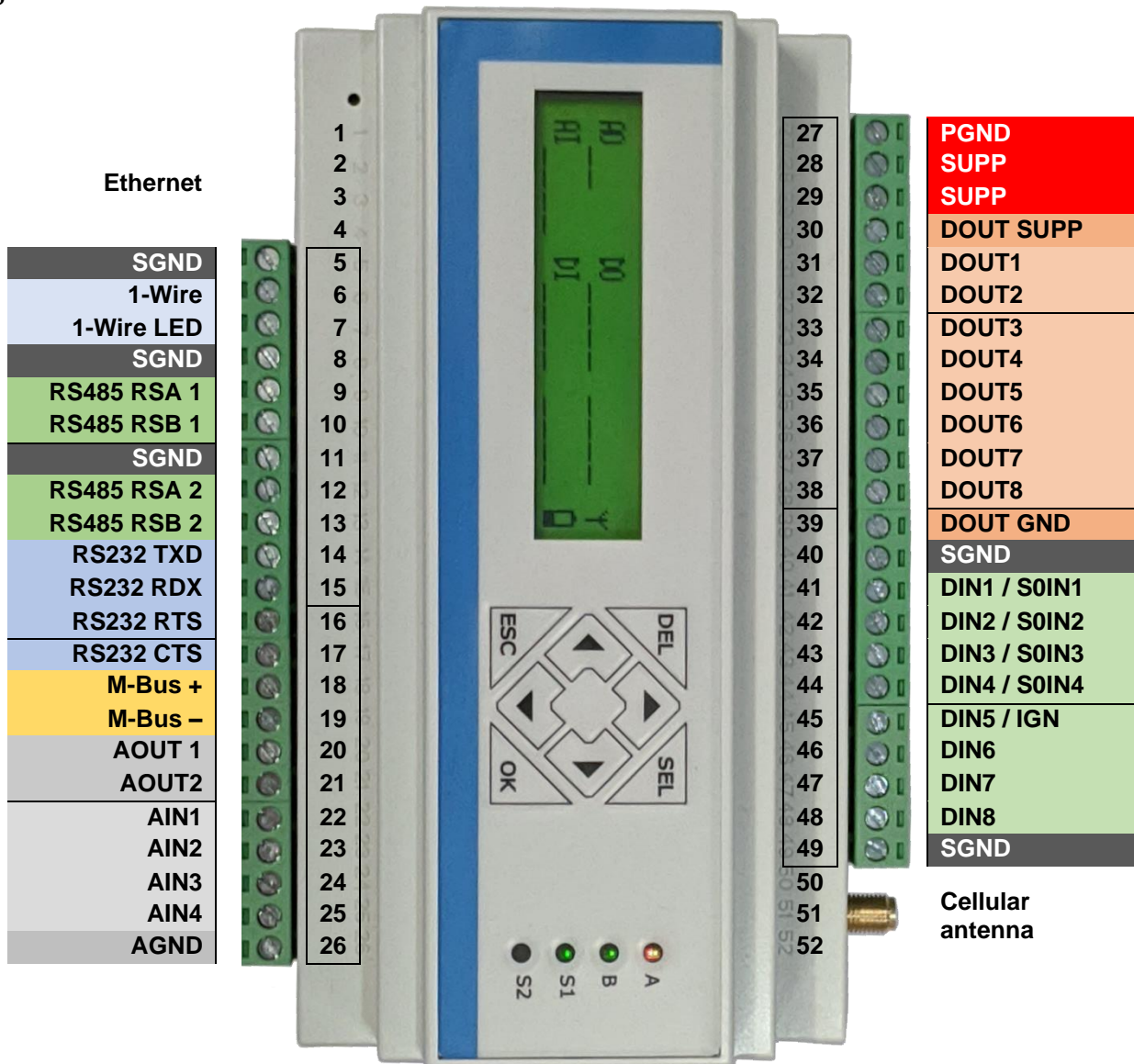

### Pin 5-26 overview

Pin	Name	Description
5	SGND	Signal ground
6	1-Wire	1-Wire bus for accessories such as ID-Button / temperature sensor
7	1-Wire LED	1-Wire ID-Button LED
8	SGND	Signal ground
9	RSA 1	RS485 non-inverting signal for the RS485 port 1
10	RSB 1	RS485 inverting signal for the RS485 port 1
11	SGND	Signal ground
12	RSA 2	RS485 non-inverting signal for the RS485 port 2

13	RSB 2	RS485 inverting signal for the RS485 port 2
14	TXD	Transmit data for the RS232 port
15	RXD	Receive data for the RS232 port
16	RTS	Request to send for the RS232 port
17	CTS	Clear to send for the RS232 port
18	M-BUS+	M-Bus signal
19	M-BUS-/SGND	M-bus ground / Signal ground
20	AOUT1	Analog output 1
21	AOUT2	Analog output 2
22	AIN1	Analog input 1
23	AIN2	Analog input 2
24	AIN3	Analog input 3
25	AIN4	Analog input 4
26	AGND	Analog Ground

#### Pin 27-49 overview

Pin	Name	Description
27	PGND	Power ground, negative (-) connection
28	SUPP	Power supply, positive (+) connection
29	SUPP	Power supply, positive (+) connection
30	DOUT SUPP	Power supply for the digital outputs
31	DOUT1	Digital output 1
32	DOUT2	Digital output 2
33	DOUT3	Digital output 3
34	DOUT4	Digital output 4
35	DOUT5	Digital output 5
36	DOUT6	Digital output 6
37	DOUT7	Digital output 7
38	DOUT8	Digital output 8
39	DOUT GND	Digital ground
40	SGND	Signal ground
41	DIN1 / S0IN1	Digital input 1
42	DIN2 / S0IN2	Digital input 2
43	DIN3 / S0IN3	Digital input 3
44	DIN4 / S0IN4	Digital input 4
45	DIN5 / IGN	Digital input 5
46	DIN6	Digital input 6
47	DIN7	Digital input 7
48	DIN8	Digital input 8
49	SGND	Signal Ground

## Mini USB-B Connector

This USB port is for programming and communication with the RTCU IDE or other RACP compliant applications. A standard USB cable can be used between the device and the PC.

## Ethernet / LAN

This is a standard 10Base-T/100Base-TX IEEE 802.3 compliant RJ45 Ethernet connector. Please use an appropriate connector and cable, such as a standard CAT-5 twisted pair patch cable. The connector has the following LED indicators that show the LINK status and communication activity.

## Power Supply

The RTCU LX4 pro device must be supplied with 8-36 VDC from an external DC power source. Positive power is applied to the SUPP pin and the ground to the PGND pin.

The SUPP and PGND are connected to the device internally through a common-mode filter. Both SUPP terminals are tied together internally.

There are four different ground labels for ground connections: Supply ground (PGND), signal ground (SGND), digital output ground (DOUT GND), and analog ground (AGND). The signal, digital output, and analog grounds are filtered from the supply ground and tied together internally. The supply ground (PGND) should only be connected to the external DC power source to filter the noise from the power source.

All the SGND terminals are tied together internally. Therefore, please choose the SGND closest to the signal terminal for the best possible noise immunity.

The RTCU LX4 pro is protected against wrong polarity. If a chassis or system ground is connected to either SGND or AGND, a wrong polarity on the supply lines will destroy the internal GND connection.

The RTCU LX4 pro contains an internal backup battery, which will supply the RTCU if the external power supply fails or is disconnected. By default, the RTCU is powered down when a power failure occurs. This setting, however, can be changed. Please consult the RTCU IDE online help for more information. When the wakeup/ignition inputs are activated with a logical high, the RTCU LX4 pro device will wake up from a power-down mode.

## Power supply pins

Pin	Name	Description
27	PGND	Power ground, negative (-) connection
28	SUPP	Power supply, positive (+) connection
29	SUPP	Power supply, positive (+) connection

## Digital outputs

The digital outputs control eight "high-side" switches. They function like contacts, where one side is connected to the positive supply of the RTCU unit, and the other side is to the output. The switches are protected against short circuits, ESD, and electronic kickback from inductive loads such as a relay. The maximum switchable inductance is 20mH and must not be exceeded.

The digital output control circuit is supplied from the power supply connected to the DOUT SUPP and DOUT GND. While the DOUT SUPP is not connected with the external DC supply input pin SUPP and needs to be connected to an external DC power source, the DOUT GND is internally connected with the system ground.

The RTCU unit offers advanced power management that can enable one or more outputs while the RTCU is in low power mode. Please consult the RTCU IDE documentation for additional information.

### Digital output pins

Pin	Name	Description
30	DOUT SUPP	Digital output supply, positive (+) connector
31	DOUT 1	Digital output 1
32	DOUT 2	Digital output 2
33	DOUT 3	Digital output 3
34	DOUT 4	Digital output 4
35	DOUT 5	Digital output 5
36	DOUT 6	Digital output 6
37	DOUT 7	Digital output 7
38	DOUT 8	Digital output 8
39	DOUT GND	Digital output ground, negative (-) connector

### Specification for each digital output

Type	Min.	Max.	Unit	
Push/Pull	0	36	VDC	Short-circuit, Overload, Overvoltage, and ESD protected
	-	1.5	A	
	-	140	mΩ	

## Digital Inputs / S0 inputs / Ignition Input

The digital inputs are all low-pass filtered and transient protected. To activate the inputs, connect a positive voltage between the input and the SGND connector.

Digital inputs 1-4 can be configured individually as S0 input (*IEC62053-31, Class A*).

By default, the digital inputs are configured as normal inputs. For placement and configuration of the hardware jumpers inside the unit, please refer to the configuration guide in Appendix A.

**Please note:** The DIN 5/IGN input is unique as it also functions as the ignition input. If the ignition input is activated with a logically high or low (Wait For Event mode only), it will wake up the unit when the RTCU is in low power mode. A power apply will also wake up the unit, if it is in power-down mode or WaitForEvent mode with power apply and/or ignition selected for wakeup.

**Please note:** Digital inputs 6-8 do not work as high-speed IO, so PCT is limited to 400Hz, and incremental encoders are not supported.

The power management allows the possibility to configure a wakeup on one or more digital inputs with individually configured falling- or rising edge detection. Please consult the RTCU IDE documentation for additional information.

### S0 compliant inputs (*IEC62053-31, Class A compatible*)

In S0 configuration, the relevant RTCU LX4 pro input will act as a 'pulse input device,' where a current source is provided on the input connector so that a simple switch between the SGND and the appropriate input will activate it. This is used in most electricity metering equipment.

S0 must be enabled from the application to work as an S0 compliant input.

**Please notice:** The RTCU LX4 pro unit must be supplied with a minimum of 16 VDC to fully comply with the S0 standard. The inputs will still work when supplied with 12VDC but will not be in compliance with the S0 standard.

### Digital input pins

Pin	Name	Description	Jumper Settings
40	SGND	Signal ground	
41	DIN1 / S0IN1	S0 input 1 Digital input 1	Row 1, Position S Row 1, Position N ( <i>default</i> )
42	DIN2 / S0IN2	S0 input 2 Digital input 2	Row 2, Position S Row 2, Position N ( <i>default</i> )
43	DIN3 / S0IN3	S0 input 3 Digital input 3	Row 3, Position S Row 3, Position N ( <i>default</i> )
44	DIN4 / S0IN4	S0 input 4 Digital input 4	Row 4, Position S Row 4, Position N ( <i>default</i> )
45	DIN5 / IGN	Digital input 5	
46	DIN6	Digital input 6	
47	DIN7	Digital input 7	
48	DIN8	Digital input 8	
49	SGND	Signal Ground	

### Specification for each digital input:

	Min.	Typ.	Max.	Unit	
Logic "High"	8	12	40	VDC	Protected against transients and low-pass filtered
Logic "Low"	-5	-	3	VDC	
Bandwidth	-	20	-	kHz	@ 12 VDC input voltage level
Input impedance	-	14	-	k $\Omega$	In "normal digital input"-mode

## Analog Inputs

The RTCU LX4 pro has four analog inputs, which can be configured individually to work either as voltage or current measurement inputs using the configuration jumpers. The range in voltage mode is 0..10 VDC, and in current mode 0..20mA.

The conversion resolution is 12 bit.

The input signal is connected between AIN<sub>x</sub> and AGND. Therefore, AGND must be connected to the reference of the connected equipment. Please be aware that deviations may occur, as the system is very noise-sensitive. Avoid long unshielded wires and significant fast-changing signals routed parallel to the analog signals.

The inputs are low-pass filtered, ESD- and transient protected.

By default, the inputs are configured as voltage inputs. For replacement and configuration of the hardware jumpers inside the device, please refer to the device configuration guide in Appendix D.

### Analog input pins

Pin	Name	Description
22	AIN1	Analog input 1
23	AIN2	Analog input 2
24	AIN3	Analog input 3
25	AIN4	Analog input 4
26	AGND	Analog Ground

### Specification for each analog input (voltage mode):

	Min.	Typ.	Max.	Unit	
Voltage	0	-	10	VDC	Protected against transients and low-pass filtered
Resolution	-	-	12	Bit	
Precision	-	0.5	0.6	%FSR	
Cut-off frequency	-	1	-	kHz	
Input impedance	-	40	-	kΩ	

### Specification for each analog input (current mode):

	Min.	Typ.	Max.	Unit	
Current	0	-	20	mA	Protected against transients and low-pass filtered
Resolution	-	-	12	Bit	
Precision	-	0.5	0.6	%FSR	
Cut-off frequency	-	1	-	kHz	
Input impedance	-	504	-	Ω	



## Analog Outputs

The RTCU LX4 pro has two analog outputs, which can be configured individually to work either as voltage or current outputs using the configuration jumpers. The range in voltage mode is 0..10 VDC, and in current mode 0..20mA. The resolution of the digital-to-analog converter is 10bit or 1024 in decimal scale.

The decimal value for 10V/20mA output is 1023, and 512 for 5V/10mA.

The output signal is connected to the external equipment between AOUTx and AGND. AGND must be connected to the reference of the connected equipment. Please be aware that deviations may occur, as the system is very noise-sensitive. Avoid long unshielded wires and significant fast-changing signals routed parallel to the analog signals. In current mode, the specifications for the analog output are only valid for a maximum load is maximum of 250Ω.

The inputs are low-pass filtered, ESD- and transient protected.

**Please notice:** The RTCU LX4 pro unit must be supplied with a minimum of 12VDC in order for the analog outputs to work according to the specifications.

By default, the outputs are configured as voltage outputs. For replacement and configuration of the hardware jumpers inside the device, please refer to the device configuration guide in Appendix D.

### Analog output pins

Pin	Name	Description
20	AOUT1	Analog output 1
21	AOUT2	Analog output 2
26	AGND	Analog Ground

### Specification for each analog output (voltage mode):

	Min.	Typ.	Max.	Unit	
Voltage	0	-	10	VDC	Protected against transients and low-pass filtered
Resolution	-	-	10	Bit	
Precision	-	0.5	0.8	%FSR	
Load	10	-	-	kΩ	

### Specification for each analog output (current mode):

	Min.	Typ.	Max.	Unit	
Current	0	-	20	mA	Protected against transients and low-pass filtered
Resolution	-	-	10	Bit	
Precision	-	0.5	0.8	%FSR	
Load	-	-	250	Ω	

## RS232 port

This port can be used as a general-purpose RS232 serial port with hardware handshake signals.

### RS232 pins.

Pin	Name	Description
11	SGND	Signal ground
14	TXD	Transmit data for the RS232 port
15	RXD	Receive data for the RS232 port
16	RTS	Request to send for the RS232 port
17	CTS	Clear to send for the RS232 port

## RS485 Port

RS485 is a multi-drop network with a maximum of 32 nodes connected simultaneously to the bus. Each RS485 bus contains an RSA and an RSB signal and a signal ground, which must always be connected to the common signal ground for all nodes connected to the RS485 bus!

The maximum cable length for the RS485 bus is according to the EIA/TIA-485-A standard (max. 1000m @ <100kbit); this limit is highly influenced by the quality of the cable, signaling rate, noise etc.

At longer cable lengths, noisy environments, or high communication speeds, it might be necessary to terminate the transmission line with a 120<sup>1</sup> ohm resistor at each end of the transmission line to terminate it and avoid signal reflections. If the RTCU LX4 pro is used as an endpoint node, the jumper for the RS485 port can be inserted in order to terminate the RS485 communication lines with 120Ω. By default, the RS485 communication lines are not terminated with 120 Ω. For placement and configuration of the hardware jumpers inside the unit, please refer to the configuration guide in Appendix A.

**Please note:** For best performance, protection, and noise immunity, it is advised to use a shielded cable to connect the device to the RS485 communications bus.

---

<sup>1</sup> Assuming use of a CAT5 twisted pair cable

### RS485 port 1

This port is available on the pluggable screw terminals and is not shared with other sources.

#### RS485 port 1 pins

Pin	Name	Description
9	RSA 1	RS485 non-inverting signal for RS485 port 1
10	RSB 1	RS485 inverting signal for RS485 port 1
8	SGND	Signal ground

### RS485 port 2

This port is available on the pluggable screw terminals and is not shared with other sources.

#### RS485 port 2 pins

Pin	Name	Description
12	RSA 2	RS485 non-inverting signal for RS485 port 2
13	RSB 2	RS485 inverting signal for RS485 port 2
11	SGND	Signal ground

## 1-Wire bus

The 1-Wire bus is available on the pluggable screw terminals. All 1-Wire communication goes through a single connection, and all 1-Wire devices connected can retrieve power directly from the bus (called parasitic power). For this, only two wires are needed – the 1-wire signal and the ground reference – allowing minimal cable installations.

For 1-Wire ID-Button readers, which include a built-in LED, a dedicated output is available for this purpose. Please consult the RTCU IDE documentation for further information.

#### RJ45 connector overview.

Pin	Name	Description
6	1Wire	1-Wire bus for ID-Button / Temperature sensor
7	1W-LED	1-Wire ID-Button LED
5	SGND	Signal Ground

#### Specification of the 1-Wire bus:

	Max.	Unit
Total weight <sup>1</sup>	65	m

<sup>1</sup> The term of weight has been described in "Modular 1-wire concept – Technical Manual" document.

## Wired M-Bus

The RTCU LX4 pro has an onboard wired M-Bus interface compliant with EN 13757-2/3 and offers a comprehensive API for communicating with up to 20 slave devices on the bus.

The M-Bus interface is short-circuiting protected and supports full master-mode functionality. The RTCU LX4 pro device needs to be supplied with an external supply for the M-Bus interface to be operational.

### M-Bus port pins

Pin	Name	Description
18	M-BUS+	M-Bus signal
19	M-BUS-/SGND	M-bus ground / Signal ground

### Specification for the M-Bus:

	Min.	Typ.	Max.	Unit	
Bus idle voltage	-	-	36	VDC	Protected against short-circuiting
Slave devices	-	-	20		
Speed	300	-	9600	bps	

## Wireless M-Bus (optional)

The RTCU LX4 pro supports an optional onboard wireless M-Bus interface compliant with EN 13757-4/7 and offers a comprehensive API for collecting data from wireless M-Bus slaves.

The Wireless M-Bus interface is designed for OMS EU/CE applications, but other variants are also available on request.

The module has support for modes S1, S2, T1, T2, and R2 as well as common reception of mode T and mode C1 in the form of mode T1+C1 and T2+C1.

### Specification for the Wireless M-Bus OMS EU/CE interface:

	Min.	Typ.	Max.	Unit
Frequency	-	868	-	MHz
Number of channels	-	12	-	
Data Rate	4.8	-	100	kchip/s
Max output power	-	-	10	dBm
Indicative LOS	-	500	-	meter

## User interface

On the front of the RTCU LX4 pro the user interface is found. This includes a 144x32 easy-to-read graphical LCD, an incorporated keypad, three bi-colored LEDs, and one single color LED.



### Graphical LCD display

The display mounted on the RTCU LX4 pro is a 144x32 pixel graphical display. A range of display functions is available for making graphical and alphanumeric presentations of the data, user interaction with menus etc.

By default, the display is powered on at start-up and shows I/O status, battery level, and cellular status as shown in the following picture:

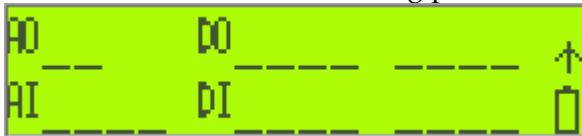





The top half of the display shows the status of the 2 analog and the 8 digital outputs (in groups of 4), the bottom half shows the status of the 4 analog and 8 digital inputs (in groups of 4).

Right-most 8x32 pixels are reserved for the battery level and the network status indication, while the rest of the display is available to the user application.

The network status and the battery level are indicated with different icons and level indicators.

The following table describes the status of the cellular network:



Status	Icon
Cellular off	
Cellular on	
Cellular on and connected	
Data connection over 2G or 3G	
Data connection over LTE	

The cellular signal level is indicated with 4 bars – also known from many mobile phones. One bar means low signal strength, and four bars represent high signal strength. No signal strength bars indicate that the cellular interface is powered up but is not connected to the network.

Similarly, the battery level is indicated with six levels: the fully charged battery icon means fully charged, and the empty battery icon means low battery level. While charging the battery, the battery icon is animated to show the charging progress.

Status	Icon
Battery level	

If LAN is enabled, the upper icon will switch between cellular status and LAN status.  
The following table describes the status of the LAN interface:

Status	Icon
Not connected	
Connected	

If the RTCU Communication Hub is enabled, the lower icon will switch between the battery status and RCH status.

The following table describes the RCH status:

Status	Icon
Not connected	
Connected	

The power state of the display is saved in persistent memory, and the state will be restored when power recycling or restarting the unit.

Please consult the RTCU IDE online manual for more information about the use of the display.

### Keypad

The keypad consists of eight pushbuttons available on the front of the unit for the user to interact with. These buttons are arranged in a logical way for easy use, and each button is marked with generally used symbols/text to fit almost every possible use.

Please consult the RTCU IDE online manual for more information about the use of the buttons.

### System Menu

The system menu can be used to view the status of the device.

To access the system menu, it must be enabled either by using `displaySysMenuEnable` to open it immediately or by using `displaySysMenuSetPassword` API to enable access to it from the keypad.

To access the system menu using the keypad, keep the OK key pressed for at least 6 seconds, and then a dialog will appear, asking for the password. If an empty password is used, this dialog is skipped, and the system menu is shown immediately.

### Password dialog:

The password is a 3-16 digit number, set with `displaySysMenuSetPassword`.

Use the up and down arrows to change the values and the left and right arrows to select the digit to change. Press OK to enter the code, ESC to close the dialog.

If the correct code is entered, it will show the system menu. The default code is 1234.



The system menu can be navigated using the arrow keys, using left/right to switch between the top-level menu items, up/down to go through the sub-menus, and ESC to exit the submenu or system menu.

The system menu currently contains the following top-level menu screens:

**Serial number:**



**Application name and version:**

Shows the application name and version. If the name is too large, it will automatically scroll to show the entire name.

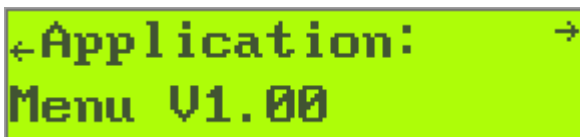

**Mobile network status:**



The arrows in the upper right corner show that this menu has submenus available using the down arrow. The sub-menus include signal status, PLMN, network type, IMEI, and IP address.

**LAN Status:**



The submenus include IP address and MAC address.

**RCH Status:**



The submenus include the RCH server address, the used network interface, and security settings.

**Power status:**



The submenus include battery level, supply voltage, and charger status.



#### IO status:



This menu can be used to manually show the IO status screen, press down to show the IO status, press an arrow key, OK, or ESC to leave the IO status.

## LED Indicators

Three bi-colored (red and green) and a single yellow LED indicators are present on the front of the unit (see the graphical overview).

Two bi-colored LED (A and B) are available to the user, and the remaining two LEDs (S1 and S2) are signaling the status and possible errors of the RTCU device.

### User LED A and B

LED A and B is composed of two individually controllable LEDs:

- LED named A on the front consists of LED 1 (green) and LED 2 (red).
- LED named B on the front consists of LED 3 (green) and LED 4 (red).

The LEDs are easily accessed from within the application program, and it is possible to mix the LEDs to obtain a third color: yellow. Please consult the RTCU IDE documentation for more information.

### System LED S1 and S2

The RTCU is equipped with two system LEDs, which show the status and possible errors of the RTCU device.

The different patterns are listed in the table below. If the color of the system LED S1 is yellow, the device actively communicates with the RTCU IDE (or another program supporting the RTCU RACP protocol).

The LED S2 signifies either the cellular engine activity or all other LEDs are off, that the RTCU is in the "wait for event" low power state.

### S1: System LED1 pattern overview

Pattern	Description
Fastest blinking, green	The device is initializing, preparing to start the application.
Fast blinking, green S2 On, green	The device is installing an update. Depending on the kind of update, it may take some time. The progress can also be observed on the display.
Fast blinking, green <sup>1</sup>	The device has been forced into recovery mode with the use of the system switch. The application is not executing.
500ms On / 500ms Off green <sup>1</sup>	The device is executing the application program
1.5s On / 0.5s Off. green <sup>1</sup>	The device is executing the application program, while charging the internal backup battery.
Fast blinking, red <sup>1</sup>	A runtime error has been detected in the program. Use the RTCU IDE to obtain the fault log.
Alternating Fast/Slow, red <sup>1</sup>	The device has lost its firmware. This can only happen if, during a firmware upgrade, the RTCU device loses power or the communication is lost completely. In this case, simply upload the firmware to the device again.
75ms On / 925ms Off, green	Execution speed is different from full-speed.
On yellow (All other Leds OFF)	The device is booting, initializing the system

### S2: System LED2 pattern overview (Cellular activity and Power saving mode)

Pattern	Operating Status
Off	The cellular engine is turned off
600 ms On / 600 ms Off	Missing SIM card or PIN code. Network search and logon in progress.
75 ms On / 3 s Off	Logged on to the network.
75 ms On / 75 ms Off / 75 ms On / 3 s OFF	A data session is active.
Flashing	Indicates a data transfer.
On	A voice session is active.
On (and all other LEDs OFF)	The system is booting.
8 s OFF / 10 ms ON (and all other LEDs OFF)	The RTCU unit is in low-power "Wait For Event" state
10 s OFF / 50 ms ON	The RTCU device is in a low-power power saving mode.

<sup>1</sup> Or yellow when communicating with the RTCU IDE or another program, supporting the RTCU RACP protocol).

## Switches

### DIP-switch

The RTCU LX4 pro unit contains four dip-switches, and three of them are available for the application to use (the *fourth dip-switch is reserved for future use*).

The dip-switches are located on the top side of the unit for easy user access (see the graphical overview).

### System switch (RST)

The RTCU LX4 pro device contains a combined reset/diagnostic switch. This switch is accessible from the front of the unit (see the graphical overview). It is necessary to use a small thin object with a diameter of approx. 2 mm, for example, a straightened-out paper clip for this purpose.

By activating the switch shortly, the RTCU device will perform a full reset.

If the reset switch is held down for approx. 3 seconds<sup>1</sup>, the device will instead enter recovery mode<sup>2</sup>, and the application will not be started. The system will automatically turn on the cellular engine in recovery mode to connect to the network and RTCU Communication Hub (if configured).

Pressing reset will also activate the device when in power-down mode. If external power is removed and the backup battery is disabled, the reset switch can still be used to boot into recovery mode, as long as there is enough power left on the battery.

---

<sup>1</sup> System LED S2 will flash green three times when this state is entered.

<sup>2</sup> System LED S1 will indicate this state by fast blinking green or yellow.

## Rechargeable Li-Ion Backup Battery

The RTCU contains an internal Li-Ion battery for operation even when the external power is absent, making it possible to report power loss etc. Please note, that when external power is removed, the device will be powered down by default. This setting can be changed as documented in the RTCU IDE documentation.

The digital and analog outputs will be disabled when a power failure occurs as the internal battery can not provide the supply voltage needed.

The battery charging is entirely automated and handled internally by the RTCU device – leaving no need for user interaction. Different kinds of functions (Battery low, Charger enable, charging status, etc.) are available to the user application.

The charge current is relatively high, for a shorter charge time, as specified in the technical specification. Make sure both the power supply and cables can handle the high current.

Whenever a power failure has occurred, the battery will be charged to establish the capacity, thus making the battery ready for the next power failure.

By default, the battery cannot be charged above 45°C or below 0°C. The RTCU offers to charge down to -10 °C using a specialized algorithm to protect the battery.

If the temperature is above 45°C, the charging will not start and will be postponed, until it is below this threshold.

The temperature has a strong influence on the battery capacity. At 0°C the capacity has dropped to 60% of the initial capacity, and it falls dramatically at lower temperatures.

The battery cycle (numbers of charges and discharges) also influences the capacity. After 300 cycles the capacity has dropped to approximately 80% of the initial capacity.

### Warning

*Misusing the RTCU device may cause the built-in battery security circuit to be damaged.*

- *Do not place the RTCU device in high-temperature locations such as in direct sunlight or near engines. Using the RTCU device in this environment may result in loss of battery performance and a shortened life expectancy.*
- *Do not expose the device to water, saltwater or allow the battery to get wet.*
- *Avoid strong impacts and shocks.*

## LTE Worldwide Cat. 4 Cellular Engine

The RTCU LX4 pro uses an LTE/UMTS/HSPA engine with the following features:

- Max. 150Mbps down / 50Mbps upload (Cat 4)
- LTE-FDD: B1/ B2/ B3/ B4/ B5/ B7/ B8/ B12/ B13/ B18/ B19/ B20/ B25/ B26/ B28.
- LTE-TDD: B38/ B39/ B40/ B41
- WCDMA: B1/ B2/ B4/ B5/ B6/ B8/ B19
- GSM: 850/900/1800/1900 MHz
- SMS (Text and PDU)
- UMTS release 7, max. 42Mbps down / 5.76Mbps upload, (Cat 6)
- Digitized audio / DTMF capability.

The Cellular Engine is designed for Worldwide deployment.

## SIM-Card

The RTCU LX4 pro device contains a standard Mini SIM card reader located inside the device. The SIM card reader is a lid-based reader with a mechanical lock system to secure the SIM card installation. Please refer to Appendix A for the SIM card installation guide.

If the SIM-card is removed during the cellular operation, the device will be rejected from the network shortly after.

## Antennas

### Cellular Antenna

The RTCU LX4 pro device contains an SMA female connector for connecting a suitable LTE compliant antenna. When installing the antenna, please ensure that the antenna is not in close proximity to metallic parts or anything else, which can influence the antenna's efficiency.

Please consult the installation guide that follows the antenna.

### Wireless M-Bus Antenna (optional)

The RTCU LX4 pro device contains an SMB male connector for connecting a suitable Wireless M-Bus (868 MHz) compliant antenna.

## SD-CARD reader

The RTCU LX4 pro device has a standard SD-card reader located on the device's top side (see the graphical overview). The RTCU LX4 pro supports a FAT file system for standard PC compatibility. In addition, SDHC cards with up to 32 GB capacity is supported.

The SD-card features a push/push eject system for reliable insertion and operation. Please refer to Appendix C for the Micro SD card installation guide.

Both the card detect and the write protect<sup>1</sup> information is available to the user through the application. Please consult the RTCU IDE on-line help for more information. Avoid removing the Micro SD card during access to the card.

### Approved SD-CARDS

*To ensure the highest performance and compatibility, it is important to use SD-CARDS approved and tested by Logic IO.*

Commercial grade SD-CARDS can be used in applications where the limited write endurance is acceptable - for example if the SD-CARD is often replaced. Commercial grade SD-CARDS should *not* be used in applications where the media's potential failure is considered mission-critical.

For applications that extensively use the SD-CARD media and where a failure is critical, it is recommended to use approved **Industrial Grade** SD-CARDS.

Logic IO has approved and recommends industrial-grade SD-CARDS from **ATP** available in capacities from 512 MB to 32 GB.

ATP Industrial Grade SD/SDHC Cards are optimized for demanding industrial applications with consistent performance in all conditions. ATP uses reliable SLC flash technology with a flash endurance more than 20 times higher than commercial grade products with MLC flash.

The differences in write endurance between commercial-grade MLC flash and ATP Industrial grade SLC flash is quite remarkable for write-intensive applications:

Product Line	Details	Total Writeable Data Prediction @ 1GB	Time Prediction @ 500 writes a day (1GB)
ATP Industrial Grade	SLC Flash	80,000GB	<b>5,740 days</b>
	+ Advanced Wear Leveling	or 2,800,000 writes	or <b>15.7 years</b>
Commercial Grade	Grade A MLC (2 bits per cell)	4,000GB	<b>280 days</b>
	+ Advanced Wear Leveling	or 140,000 writes	

<sup>1</sup> This signal is not available, but for compatibility reason the software function will always return "not write protected"

## Product Identification Label with Barcode

The RTCU LX4 pro product identification is found on the device's exterior and contains a unique serial number in readable form and barcode.

The first three digits in the serial number identify the device type, and for the RTCU LX4 pro, this unique code is **360** or **361**.

**Barcode format used:** 2/5 Interleaved with check-digit.

## Power Consumption

The table below shows detailed information about the RTCU LX4 pro device's typical power consumption while it is running.

### Typical power consumption: Device operating in normal mode

	12V	24V	BAT	
Device active (without the LCD)	45	23	200	mA
Device active (with the LCD)	70	35	200	mA
Device active with Cellular on*	65	33	130	mA idle @ -51dBm* 42G)
Device active with a data session*	110	55	260	mA @ -51dBm, Battery not charging*
Device active with Ethernet on	125	63	250	mA Connected to switch, file transfer over the RCH
Device active while charging	400	200	-	mA

**Note:** Values marked with (\*) are averaged and should be considered guidelines as they may vary depending on the cellular signal strength.

**Note:** Power consumption from the battery @ 3.8V

The table below shows detailed information about the RTCU LX4 pro device's typical power consumption in power-saving modes.

The following power-saving modes are used:

- Mode 1: LED blinks every ~10 s, resumes the application when it is awoken.
- Power down: The device is powered down.

See the RTCU IDE online manual for information about how to use the power-saving modes.

Wake-up source	Mode 1			Power down			
	12V	24V	BAT	12V	24V	BAT	
Cellular*	2	1.2	5	-	-	-	mA
RS232 Mode 1	2	1.2	5	-	-	-	mA
RS485 Mode 1	2	1.2	5	-	-	-	mA
Din 5/Ignition	1.8	0.9	4	0.5	0.3	0.7	mA
Din 1-4	1.8	0.9	4	-	-	-	mA
Power Failure	1.8	0.9	4	-	-	-	mA
Power Apply	1.8	0.9	4	0.5	0.3	0.7	mA
Time	1.8	0.9	4	0.5	0.3	0.7	mA

**Note:** Power consumption from the battery @ 3.8V

**Note:** Values marked with (\*) are averaged and should be considered guidelines, as they vary, depending on the signal strength.



## Appendices

### Appendix A – Device configuration guide

The RTCU LX4 pro has many features, and some of them require configuration by using hardware jumpers inside the unit.

It is necessary to open the device to access the internal SIM-card reader and the configuration jumpers.

#### Opening the device

Make sure that the SD card and USB cable have been removed.

Release the tap on the right side by pulling out on the top part of the encapsulation below the tap, e.g. using a screwdriver, and begin lifting the right side.

Carefully open the encapsulation, taking care to not pull on the flexible flat cable on the left side.

The cable is long enough to allow the top part to be placed on its end or on the front, next to the bottom part:

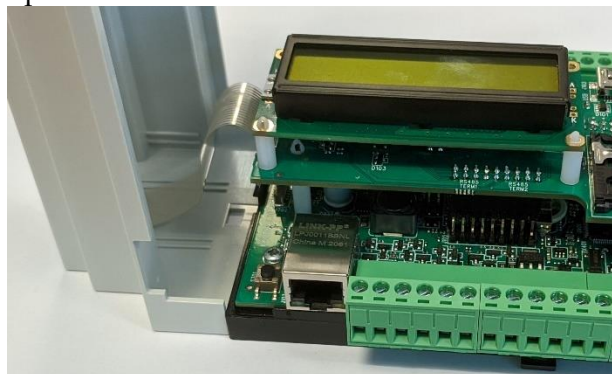

#### Closing the device

The assembly process of the encapsulation is in the reverse order of the above steps.

To prevent the cable from getting caught between the parts, it is recommended to use a finger to push it partially into the space between the LCD PCB and the middle PCB while closing the lid, as shown on the image to the right.

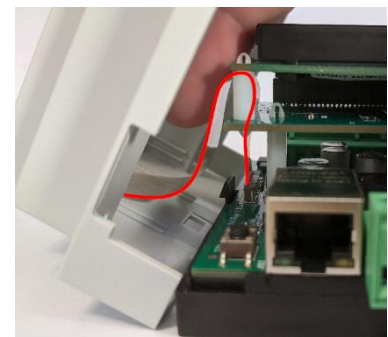

## Configuration

The following figure shows the location of the jumpers when the lid is removed. The blue shaded boxes show the default state of the jumpers.

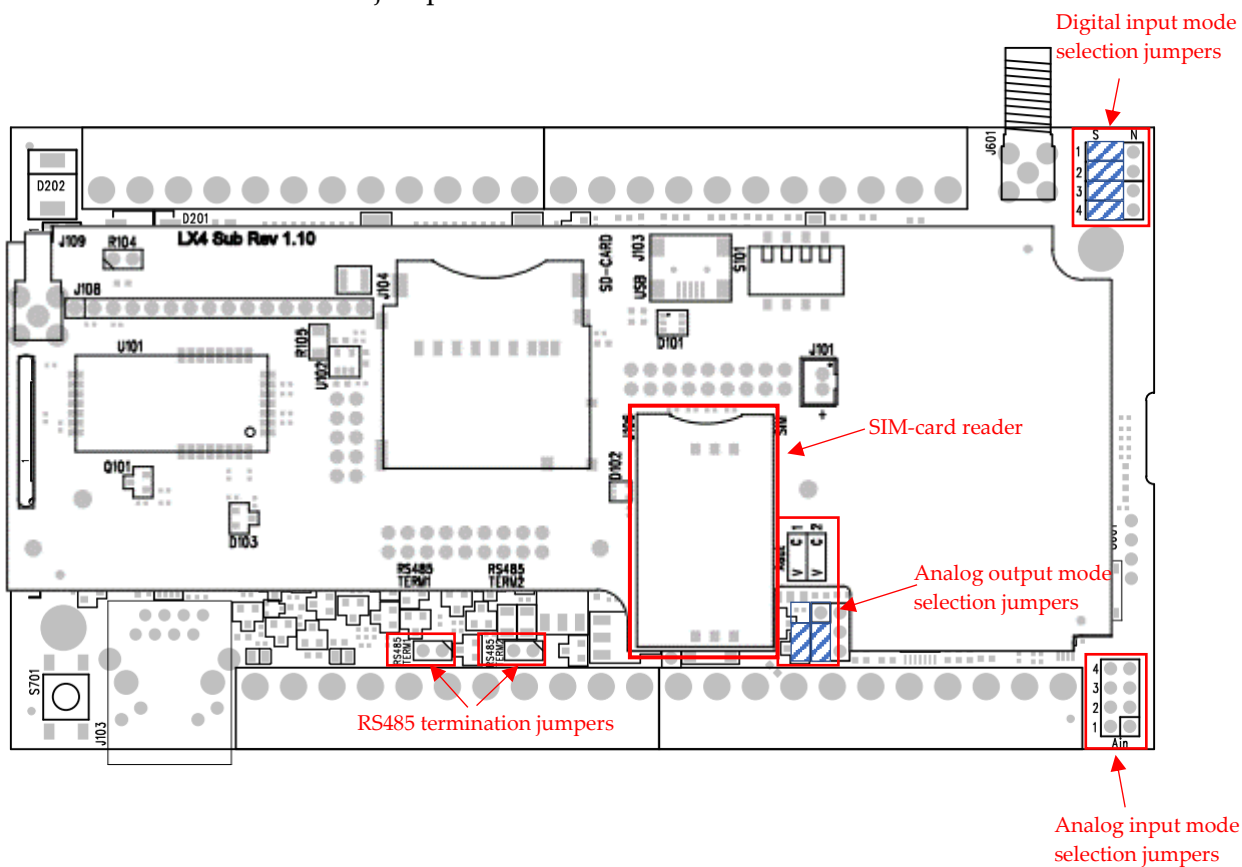

Feature	Jumper	State	Function	Default State
Communication	RS485 TERM1	Installed	RS485 port 1 line 120 Ω resistor enabled	Not installed
		Not installed	RS485 port 1 line 120 Ω resistor disabled	
	RS485 TERM2	Installed	RS485 port 2 line 120 Ω resistor enabled	Not installed
		Not installed	RS485 port 2 line 120 Ω resistor disabled	
Analog input	Ain 1	Installed	Ain 1 current mode selected	Not installed
		Not installed	Ain 1 voltage mode selected	
	Ain 2	Installed	Ain 2 current mode selected	
		Not installed	Ain 2 voltage mode selected	
Ain 3	Installed	Ain 3 current mode selected		
	Not installed	Ain 3 voltage mode selected		
Ain 4	Installed	Ain 4 current mode selected		
	Not installed	Ain 4 voltage mode selected		
Analog output	Aout 1	Position C	Aout 1 current mode selected	Position V
		Position V	Aout 1 voltage mode selected	
	Aout 2	Position C	Aout 2 current mode selected	Position V
		Position V	Aout 2 voltage mode selected	
Digital input	Din 1	Position S	Din 1 S0 mode selected	Position N
		Position N	Din 1 normal mode selected	
	Din 2	Position S	Din 2 S0 mode selected	
		Position N	Din 2 normal mode selected	
Din 3	Position S	Din 3 S0 mode selected		
	Position N	Din 3 normal mode selected		
Din 4	Position S	Din 4 S0 mode selected		
	Position N	Din 4 normal mode selected		

### RS485 TERM1 /RS485 TERM2

Enables/disables the onboard 120 Ω line termination resistors according to the standards; RS485 communication requires a proper line termination value (120 Ω assuming a CAT5 twisted pair cable is used) resistors in both ends of the bus. If the RTCU LX4 pro device is used as an endpoint, the relevant jumper can be installed.

### Ain 1 – Ain 4

These jumpers are used to select between current and voltage input measurement. A jumper installed on the position C for the relevant analog output will source current between 0-20mA, while in position V, it will source a voltage level between 0-10V.

### Aout 1 – Aout 2

These jumpers are used to select between current and voltage output. With a jumper installed on the relevant analog output, it will source a current between 0-20mA.

### Din 1 – Din 4

These jumpers are used to select between standard digital input or S0 input. With a jumper installed on position S (pin 1 and pin 2), it will act as S0 input, while position N will operate as normal digital input.

### Appendix B – Installing the SIM-Card

*Please refer to Appendix A to get inside access to the device.*

The SIM card reader is a lid-based type with a mechanical lock for the insertion of a mini-SIM card.

Open the hinged lid on the SIM card reader, orientate the card as shown below, and insert it into the card reader's lid. Close the lid and slide the metal locking mechanism to the locked position, as shown with an arrow and text on the lid until a click is heard.

To remove the card, slide the metal locking mechanism to the unlocked position as shown with an arrow and text on the lid, and open the lid. The SIM card can now be removed.



**SIM card orientation**

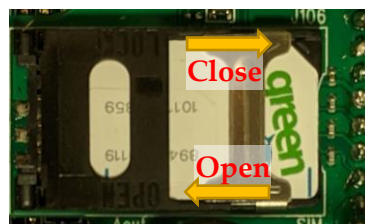

**SIM card inserted and locked**

## **Appendix C - Open Source Disclaimer**

The RTCU LX4 pro products include several open-source software tools. This open-source software is governed by the terms and conditions of the applicable open source license. You are bound by the terms and conditions of the appropriate open source license in connection with your use and distribution of the open-source software in this product.

Please refer to the separate document "**RTCU Open Source Licenses.pdf**" for detailed information about the packages used.

## RTCU LX4 pro Specifications

### RTCU M2M Platform

- NX32 for Linux - NX32L.
- Fully NX32 compatible.
- Hardened execution environment.
- Full TLS/ SSL support.

### LX Hardware Core

- Powerful 132-bit ARM processor.
- Hardware floating point and DSP.
- 128 Mbyte RAM.
- 256 Mbyte NAND flash.
- Real-time clock with battery-backup.

### Storage

- Internal flash drive (Up to 64 MByte).
- Persistent data flash.
- Multiple circular dataloggers.
- SD-card reader.

### Cellular Engine

- **LTE Cat.4 Engine (Worldwide).**  
Max 150 Mbps(DL)/ Max 50 Mbps(UL).  
LTE FDD: 15 bands.  
LTE-TDD: 4 bands.  
WCDMA: 7 bands.  
GSM: Quad-band.
- DTMF decoding / transmission.
- Digitized voice playback / IVR.
- Internal SIM-card reader.
- Optional eSIM.

### Communication Interfaces

- 100BASE-T Ethernet interface.
- 1 x RS232 with RTS/ CTS.
- 2 x RS485.
- 1-Wire bus with LED support
- Wired M-Bus with up to 20 slaves.  
Compliant with EN13757 2/ 3.
- Optional: wM-Bus. Mode S, T, C, R2.  
Compliant with EN13757 4/ 7 OMS.
- USB service/ programming port.

### Digital I/ O Interface

- 8 x digital solid-state digital output.  
Max. 36 volt / 1.5 A per. channel.  
Short-circuit, ESD, Inductive kick-back protected up to 20 mH.  
User supplied power source.
- 8 x digital inputs.  
Logic high: 8 to 40 VDC.  
Logic low: -5 to 3 VDC.  
Impedance: 3.3kohm @ 12V.
- 4 x IEC62053-31 Class A input.

### Analog I/ O Interface

- 4 x analog inputs.  
Range is 0..10VDC or 0..20 mA  
Resolution: 12 bit  
Accuracy: Typ.  $\pm 0.5\%$  FSR @ 25°C  
Impedance: 40 kohm (V)/ 504 ohm (C).
- 2 x analog outputs.  
Range is 0..10VDC or 0..20 mA  
Resolution: 10 bit  
Accuracy: Typ.  $\pm 0.5\%$  FSR @ 25°C.
- Protected against transients and low-pass filtered.

### User Interaction

- 144x32 pixels graphical/ text display with black text on green a back-lit background.
- Keypad with 8 user defined keys.
- 3 x bi-colour LED / Yellow status LED.
- DIP-switches.
- I/ O configuration jumpers for digital and analog modes.
- Jumper for RS485 termination
- Reset / recovery switch.

### Battery and Charger

- On-board 2Ah (nominal) Li-Ion battery.
- Intelligent charger with temperature throttle and sub-zero degrees support.
- On-board temperature sensor.

### Electrical

- Supply operating range: 8 to 36 VDC.
- Short and reverse power protected.

### External Interfaces

- Two-part pluggable connector for: Power, I/O, RS232, RS485, Wired M-Bus.
- RJ45 for LAN with LED status.
- SD-card slot with presence and write protect detection.
- SMA Female connector for cellular.
- Optional: SMB male for Wireless M-bus.
- LED indicators and DIP switches.
- Reset/ recovery switch.
- Mini USB-B as service port.

### Physical Characteristics

- Encapsulation:  
9 Module M36 DIN-rail.
- Approx. 430 gram without accessories.
- W 157 x H 86 x D 58 mm.  
(without SMA and screw-terminals).

### Environmental Specification

- Operating temperature: -30 to 60°C.
- Battery charge temperature:  
-10 to 45 °C
- Recommended storage temperature:  
0 to 45°C.
- Humidity: 5..90% (non condensing).
- Ingress Protection: IP20 .

### Approvals

- 2014/ 53/ EU Radio Equipment Directive.
- 2014/ 30/ EU EMC Directive
- 2011/ 65/ EU RoHS Directive.

### Warranty

- Two-years return to factory parts and labor.
- Optional warranty up to 5 years.  
(restrictions apply).



\*\*\*\* END OF DOCUMENT \*\*\*\*