

Technical Manual for the RTCU AX9 pro

Version 1.05



Introduction

This manual contains technical documentation allowing easy installation and use of the RTCU AX9 pro product. For information on the programming and software configuration of the RTCU AX9 pro please refer to the RTCU IDE documentation.

The RTCU AX9 pro has been designed ground up for professional wireless industrial applications with its strong on-board I/O capabilities and multiple communication interfaces such as: 1-Wire, USB, dual RS232 and RS485 channels. In addition to full quad-band GSM for long-range wireless communication the RTCU AX9 pro integrates support for RF ISM for short range wireless communication.

The on-board I/O system can be expanded almost indefinitely and completely transparent by adding external MODBUS compatible I/O modules! This unique I/O expansion capability, combined with the possibility to operate as a MODBUS master and slave simultaneously, positions the RTCU AX9 pro as the perfect product for SCADA-like applications.

The RTCU AX9 pro offers many other sophisticated features such as: A 512 Kbyte internal flash drive and a Micro SD card reader with a FAT32 compatible file-system for easy sharing of files locally and remotely with a PC/Server. There is optional support for Bluetooth, Ethernet, Wi-Fi, Camera module and a Mobile Data Terminal for user interaction.

The RTCU AX9 pro is based on the well proven RTCU X32-architecture sharing powerful features such as: IVR (Interactive Voice Response) implementation using Voice/DTMF, SMS/PDU messages, optimized host implemented TCP/IP stack with full support the Logic IO Gateway concept. Using the Logic IO VSMS (Virtual SMS) technology SMS, GPRS and CSD (Datacall) merges together allowing any RTCU application, which uses the VSMS-messages paradigm to transparently send / receive messages using SMS, GPRS or CSD (Datacall) *without* any changes to the software already developed. The unit has full SMTP support for sending e-mails with attachments and file transfer with FTP for easy exchange of information with external sources.

The RTCU AX9 pro is of course fully programmable using the user-friendly Integrated Development Environment (RTCU IDE) running under Windows.

The advanced power-management features on the RTCU AX9 pro combined with the on-board high-capacity Li-Ion battery allows the unit to stay in power-saving mode for a longer period of time still being connected to the GSM network and capable of waking up on for example GSM activity, change of digital inputs and many other events.

These features open up for the use of the RTCU AX9 pro in exciting new application areas where extremely low power consumption and flexible wake-up conditions are a crucial parameter for successful product integration.

Table of Contents

Introduction	2
Table of Contents	3
Graphical view.....	4
Connection Overview	5
Power supply.....	8
DC Supply	9
AC Supply	10
Digital I/O	11
Relay outputs	11
Digital inputs / S0 inputs / wakeup (<i>ignition</i>) input.....	12
Analog I/O	14
Analog inputs	14
Analog outputs	15
USB programming port.....	16
RS232 communication ports (EIA/TIA-232 and V.28/V.24 compatible)	16
Serial port 1.....	16
Serial port 2.....	16
RS485 communication ports (<i>EIA/TIA-485-A compatible</i>)	17
RS485 port 1 (<i>standard</i>).....	18
RS485 port 2 (<i>optional</i>)	18
1-Wire	19
DC-Out.....	19
3.3V DC-Out.....	19
12V DC-Out.....	19
LED's	20
Switches.....	22
DIP-Switch	22
System switch (<i>Reset</i>).....	22
Internal Li-Ion battery	23
GSM.....	24
GSM Antenna(s).....	24
SIM-Card.....	24
Micro SD card reader	25
Micro SD card reader	25
868MHz ISM RF.....	26
Barcode.....	26
Power consumption.....	27
External DC supply.....	27
Internal battery	27
External AC supply.....	28
Specifications for the RTCU AX9 pro	29
Appendix A – Unit configuration guide.....	30
Appendix B – Installing the SIM card.....	32
Appendix C – Installing the Micro SD card	33

Graphical view

On the front of the RTCU AX9 pro are four user controlled LED's and two system LED's for simple information and status.

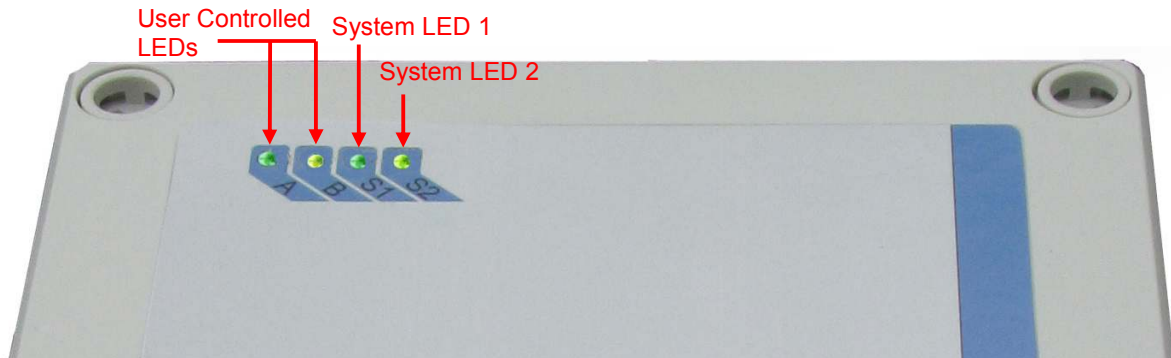

The RTCU AX9 pro is available in two versions:

- Internal quad band GSM antenna (RTCU AX9 pro).
- External quad band antenna by female SMA connector (RTCU AX9 pro-x) as shown below:



Connection Overview

Connections to external equipment are done via large and easy-to-use screw terminal blocks which are accessible when the lid is removed. The placement of the terminals makes installation easy using the PG glands and thereby maintaining the IP-67 protection. The RTCU AX9 pro is delivered with three PG11 glands and additional two PG9 blind plugs that can be replaced with PG9 glands if additional cable entry capacity should be required.

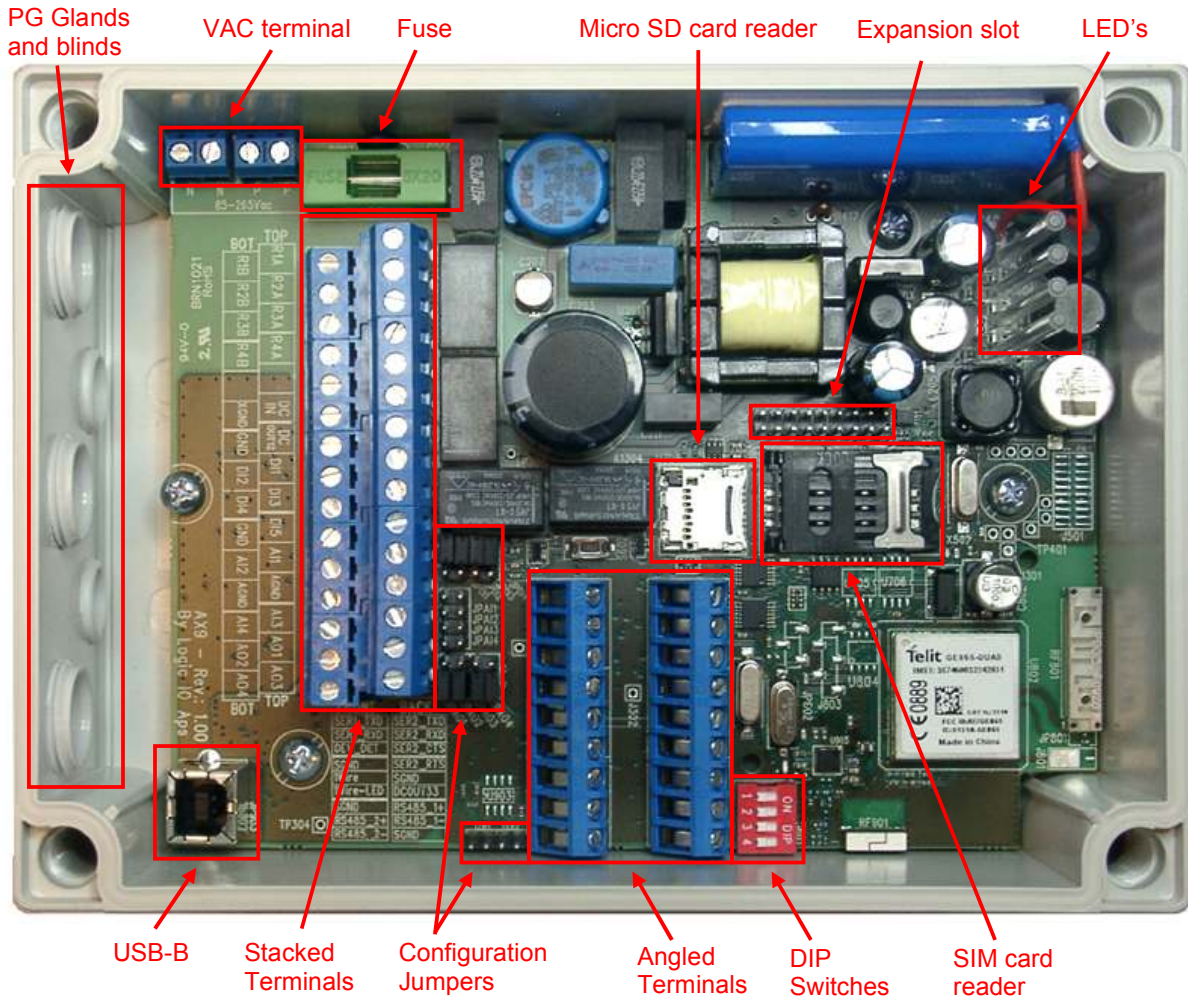

The stacked terminals contain connections for: analog and digital inputs/outputs, +12V DC-Output and DC power input.

The angled terminals contain connections for the communication interfaces: RS232 Port 1, RS232 Port 2, RS485 Port 1, RS485 Port 2 (*optional*), 1-Wire and the +3.3V DC-Output.

Also located inside the RTCU AX9 pro are the; SIM card reader, Micro SD card reader, three DIP switches and a USB-B connector for RTCU IDE connection.

Stacked terminal overview.

Terminal Name		Description
TOP row	BOT row	
R1A		Contact set for relay output 1
	R1B	
R2A		Contact set for relay output 2
	R2B	
R3A		Contact set for relay output 3
	R3B	
R4A		Contact set for relay output 4
	R4B	
N.C		Not connected
	N.C	Not connected
DCIN		DC power supply, positive (+) connection
	XGND	DC power ground, negative (-) connection
DCOUT12		+12V / 750mA DC output for external equipment
	GND	Signal ground
DI1		Digital input 1 / S0 input 1
	DI2	Digital input 2 / S0 input 2
DI3		Digital input 3 / S0 input 3
	DI4	Digital input 4 / S0 input 4
DI5		Digital input 5 / Wakeup (<i>ignition</i>) input
	GND	Signal ground
AI1		Analog input 1
	AI2	Analog input 2
AGND		Analog ground
	AGND	Analog ground
AI3		Analog input 3
	AI4	Analog input 4
AO1		Analog output 1
	AO2	Analog output 2
AO3		Analog output 3
	AO4	Analog output 4

Angled terminal front row overview.

Terminal Name	Description
SER1_TXD	Transmit data from serial port 1, RS232 compatible
SER1_RXD	Receive data for serial port 1, RS232 compatible
DEV_DET	Reserved for accessories.
SGND	Signal ground
1Wire	1-Wire bus for ID-Button / Temperature sensor
1Wire-LED	1-Wire ID-Button LED output
SGND	Signal ground
RS485_2+	RS485 non-inverting signal for optional RS485 port
RS485_2-	RS485 inverting signal for optional RS485 port

Angled terminal back row overview.

Terminal Name	Description
SER2_TXD	Transmit data from serial port 2, RS232 compatible
SER2_RXD	Receive data for serial port 2, RS232 compatible
SER2_CTS	Clear-To-Send for serial port 2, RS232 compatible
SER2_RTS	Request-To-Send for serial port 2, RS232 compatible
SGND	Signal ground
DCOUT33	+3.3V / 400mA DC output for external equipment
RS485_1+	RS485 non-inverting signal for standard RS485 port
RS485_1-	RS485 inverting signal for standard RS485 port
SGND	Signal ground

VAC terminal overview.

Terminal Name	Description
N	85-265VAC (50/60Hz) Null input
N	<i>(internally connected)</i>
P	85-265VAC (50/60Hz) Phase input
P	<i>(internally connected)</i>

USB-B connector.

This is a standard USB-B connector and is used for communicating with the RTCU IDE (RACP compliant application).

Power supply

The RTCU AX9 pro unit can be supplied with either 85-265VAC (50/60Hz) or 8-36VDC or both supply types simultaneously.

The RTCU AX9 pro also contains an internal high capacity backup battery, which will supply the RTCU if the external power should fail or be disconnected. By default the RTCU AX9 pro is powered down when a power fail occur. This setting however can be changed. Please consult the RTCU-IDE on-line help for more information.

When the wakeup/ignition input is activated with a logical high, the RTCU AX9 pro unit will wake up if it was in power down mode.

There are four different ground labels: External Ground (XGND), Signal Ground (SGND), Digital Ground (GND) and Analog Ground (AGND). The signal, digital and analog grounds are filtered from the power ground. External ground must only be used as DC power supply return path. The digital ground is used as ground reference for digital I/O's, signal ground is used as ground reference for serial interfaces, and the analog ground is used as a low noise analog ground reference for the analog inputs.

Dual Supply Note:

The RTCU AX9 pro unit can be supplied with both VAC and VDC at the same time. The unit will run on the VAC supply if the VDC supply voltage is $\leq +16\text{VDC}$. If the VDC supply voltage is higher it will run on the VDC supply.

Please refer to the RTCU on-line help for information on how to check the supply type from within an application.

DC Supply

The RTCU AX9 pro unit can be supplied with 8-36VDC from an external DC power source. Positive power is applied to the DCIN pin and ground is connected to the XGND pin.

The DC supply of the RTCU AX9 pro is protected against wrong polarity. If a system ground are connected to either SGND or AGND a wrong polarity on the supply lines will destroy the internal GND connection.

Please Note:

- Minimum 14VDC supply is necessary for 0-10V analog output configuration.
- Minimum 16VDC supply is necessary for digital inputs 1-4 to work as S0 compliant inputs.

VDC Supply terminals.

Terminal Name	Description
DCIN	Power supply, positive (+) connection
XGND	Power ground, negative (-) connection

AC Supply

The RTCU AX9 pro unit can be supplied with 85-265VAC (50/60Hz) from a standard wall plug or any other high-voltage VAC power rail.

The AC supply of the RTCU AX9 pro is a high-efficient switch mode power supply and the AC input is protected with a 1A/250V Fast Acting fuse.

The AC must be applied between the **N** and **P** on the separate located screw terminals.

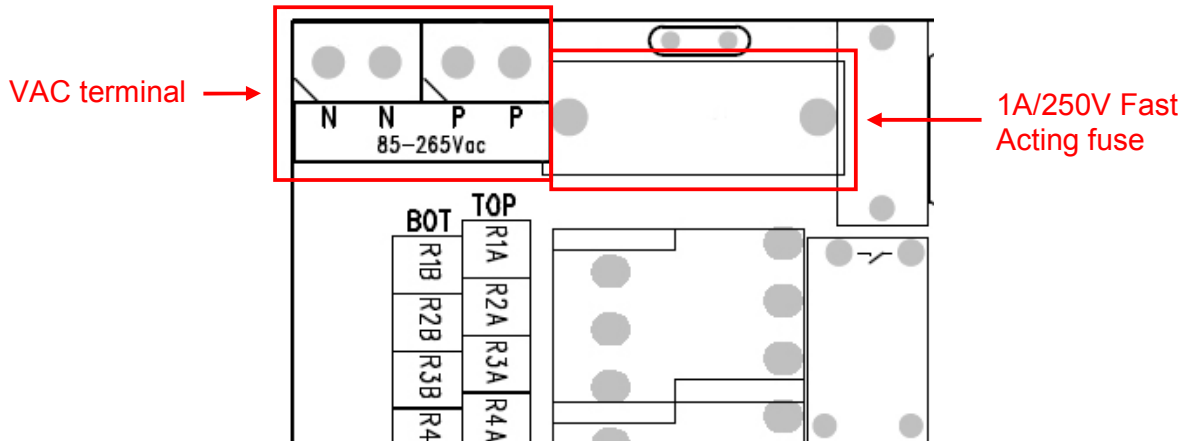

VAC Supply terminals.

Terminal Name	Description
N	85-265VAC (50/60Hz) Null input
N	<i>(internally connected)</i>
P	85-265VAC (50/60Hz) Phase input
P	<i>(internally connected)</i>

Please Note:

The two pairs of **N** and **P** terminals are internally connected.



There is high voltage on certain areas of the PCB (Printed Circuit Board) when supplied with AC mains. There is risk of electrical hazard, avoid touching the PCB and the components during operation.

Be aware that the supply filter contains capacitors that may remain charged after the equipment is disconnected from the supply. Although the stored energy is within the approved safety requirements, a slight shock may be felt if the plug pins are touched immediately after removal.

Refer all servicing and handling to qualified personnel.

Digital I/O

The RTCU AX9 pro unit has five digital inputs and four normally-open relay outputs.

The outputs are high performance relays with good current handling capabilities.

Digital input 1-5 has several operation modes. Please refer to the digital input section for additional information.

Relay outputs

The digital outputs control four relays and they act like a normally-open contact, where one side must be connected to a source that needs switching and the other contact terminal is the output. The source can be either VAC or VDC but the maximum switchable voltage and current must not be exceeded, please refer to specification page.

There are no internal connections to the relay outputs and therefore a source must always be connected to one of the relay terminals for the output to work. If power is removed or a power-fail occurs on the RTCU AX9 pro will switch to normally-open.

The RTCU AX9 pro unit offers a very advanced power management, which makes it possible to have one or more outputs enabled while the RTCU is in low power mode. Please consult the RTCU IDE on-line help for more information.

Relay output terminals.

Terminal Name	Description
R1A	Contact set for relay output 1
R1B	
R2A	Contact set for relay output 2
R2B	
R3A	Contact set for relay output 3
R3B	
R4A	Contact set for relay output 4
R4B	

Load Noise

If highly inductive loads are connected to the relays it is recommended that a noise limiting component is used. Using a TVS diode (for AC applications) or kickback diode (for DC applications) shunted across the load will assist in dissipating voltage transients.

Digital inputs / S0 inputs / wakeup (*ignition*) input

The five digital inputs are all low-pass filtered (450kHz) and transient protected. To activate the inputs, connect a positive voltage between the corresponding input DIx and GND. Please refer to the specification page for correct logic level voltage ranges.

Digital input 1-4 can individually be configured as S0 input (*IEC62053-31, Class A*) and DI5 can work as wakeup (*ignition*) input.

By default the digital inputs are configured as normal inputs. For placement and configuration of the hardware jumpers internally, please refer to the configuration guide in Appendix A.

S0 compliant inputs (*IEC62053-31, Class A compatible*)

In S0 configuration the relevant RTCU AX9 pro input will act as 'pulse input device' and a current is supplied into the input connector, so that a simple switch between GND and the appropriate input will activate it. This is used in most electricity metering equipment.

The S0 circuit is by default enabled and can be disabled to save power. Please refer to RTCU IDE on-line help for more information.

Please Note: The RTCU AX9 pro unit must be supplied with minimum 16VDC or AC.

Wakeup (*ignition*) input

The DI5 / Wakeup (*ignition*) input is a special input as it also functions as the wakeup input. If the input is activated with a logical high or low (Wait-For-Event mode only) when the RTCU AX9 pro is in low power mode it will wakeup the unit. A power apply will also wake the unit up if it is in power-down mode or in Wait-For-Event mode with power Apply and/or ignition selected for wakeup.

The input is de-bounced with a period between 1-2 ms when used as a digital input. So any logical level applied to this input must be greater than 2 ms to be valid.

The power management allows the possibility to configure a wakeup on one or more digital inputs with individually configured falling- or rising edge detection. Please consult the RTCU IDE on-line help for more information.

For placement and configuration of the hardware jumpers inside the unit, please refer to the unit configuration guide in Appendix A.

Digital input terminals.

Terminal Name	Description	Jumper Setting
DI1	Digital input 1 or S0 input 1	JPDI1 in position N (<i>default</i>) JPDI1 in position S
DI2	Digital input 2 or S0 input 2	JPDI2 in position N (<i>default</i>) JPDI2 in position S
DI3	Digital input 3 or S0 input 3	JPDI3 in position N (<i>default</i>) JPDI3 in position S
DI4	Digital input 4 or S0 input 4	JPDI4 in position N (<i>default</i>) JPDI4 in position S
DI5	Digital input 5 and Wakeup (<i>ignition</i>) input	
GND	Digital Ground	

Analog I/O

The RTCU AX9 pro unit has four analog inputs and four analog outputs. Both the inputs and the outputs have a resolution of 10 bits.

Each of the individual inputs and outputs can be configured to work either in voltage or current mode. The range in voltage mode is 0-10VDC and 0-20mA in current mode.

Analog inputs

The input signal must be connected between AIx and AGND. AGND must be connected to the reference of the connected equipment. Please be aware that deviations may occur, as the system is very noise sensitive. Avoid long unshielded wires and large fast-changing signals routed parallel to the analog signals. The impedance of the analog inputs is 40kΩ.

The decimal value with 10V/20mA applied to the input is 1023 and 512 for 5V/10mA.

Each input is low-pass filtered, ESD and transient protected.

As default the inputs are configured as voltage inputs. For placement and configuration of the hardware jumpers inside the unit, please refer to the unit configuration guide in Appendix A.

Analog input terminals.

Terminal Name	Description	Jumper Setting
AI1	Analog input 1 – Voltage	JPAI1 not installed (<i>default</i>)
	Analog input 1 – Current	JPAI1 installed
AI2	Analog input 2 – Voltage	JPAI2 not installed (<i>default</i>)
	Analog input 2 – Current	JPAI2 installed
AI3	Analog input 3 – Voltage	JPAI3 not installed (<i>default</i>)
	Analog input 3 – Current	JPAI3 installed
AI4	Analog input 4 – Voltage	JPAI4 not installed (<i>default</i>)
	Analog input 4 – Current	JPAI4 installed
AGND	Analog ground	
AGND	Analog ground	

Analog outputs

The output signal must be connected to external equipment between AOx and AGND. AGND must be connected to the reference of the connected equipment. Each output is ESD and transient protected. Please be aware that deviations may occur, as the system is very noise sensitive. Avoid long unshielded wires and large fast-changing signals routed parallel to the analog signals. In current mode the specifications for the analog output only valid if the load is maximal 250Ω.

The decimal value for 10V/20mA output are 1023 and 512 for 5V/10mA.

As default the outputs are configured as voltage outputs. For placement and configuration of the hardware jumpers inside the unit, please refer to the unit configuration guide in Appendix A.

Please note: The RTCU AX9 pro unit must be supplied with minimum 14VDC or AC in order for the analog outputs work according to specifications.

Analog output terminals.

Terminal Name	Description	Jumper Setting
AO1	Analog output 1 – Voltage	JPAO1 in position V (<i>default</i>)
	Analog output 1 – Current	JPAO1 in position C
AO2	Analog output 2 – Voltage	JPAO2 in position V (<i>default</i>)
	Analog output 2 – Current	JPAO2 in position C
AO3	Analog output 3 – Voltage	JPAO3 in position V (<i>default</i>)
	Analog output 3 – Current	JPAO3 in position C
AO4	Analog output 4 – Voltage	JPAO4 in position V (<i>default</i>)
	Analog output 4 – Current	JPAO4 in position C
AGND	Analog ground	
AGND	Analog ground	

USB programming port

The USB port is for programming and communicating with the RTCU IDE (RACP compliant application). A standard USB cable can be used between the unit and the PC.

RS232 communication ports (EIA/TIA-232 and V.28/V.24 compatible)

Two general purpose RS232 ports available on the RTCU AX9 pro unit. Both are compliant with the EIA/TIA-232 standard.

Serial port 1

This port is a general-purpose RS232 serial port and does not support handshaking. This serial port share resources with the optional RS485 port and only one of them can be active at a given time.

The signals are available on the angled front row terminals.

SER1 terminals.

Terminal Name	Description
SER1_TXD	Transmit data from serial port 1, RS232 compatible
SER1_RXD	Receive data for serial port 1, RS232 compatible
SGND	Signal ground

Serial port 2

Serial port 2 is a general-purpose RS232 port with RTS/CTS handshaking signals present.

The signals are available on the angled back row terminals.

SER2 terminals.

Terminal Name	Description
SER2_TXD	Transmit data from serial port 2, RS232 compatible
SER2_RXD	Receive data for serial port 2, RS232 compatible
SER2_CTS	Clear-To-Send
SER2_RTS	Request-To-Send
SGND	Signal ground

RS485 communication ports (*EIA/TIA-485-A compatible*)

RS485 is a multi-drop network with a maximum of 32 units connected simultaneously to the bus. The RS485 bus contains a RS485+ (*non-inverting*) and a RS485- (*inverting*) signal, as well as a signal ground, which must always be connected to the common signal ground for all units connected to the RS485 bus!

The maximum cable length for the RS485 bus is according to EIA/TIA-485-A standard (max. 1200m @ <100kbit); this limit is highly influenced by the quality of the cable, signaling rate, noise etc.

At longer cable lengths, noisy environments or high communication speed it might be necessary to terminate the transmission line with a 120¹ ohm resistor at each end of the transmission line to terminate it and avoid signal reflections.

If the RTCU AX9 pro is used as endpoint unit the hardware jumper TER1 (*standard port*) and TER2 (*optional port*) can be installed to terminate the RS485 communication lines with 120Ω.

Both the standard and the optional RS485 port can be used as general-purpose RS485 serial port or as IO extension module(s) port. When used with supported MODBUS IO extension modules, general purpose use is disabled. The RS485 port signals are available on the angled terminals.

Further details on the MODBUS IO extension modules and use are available in the RTCU-IDE on-line help.

By default the RS485 communication lines are not terminated with 120 ohm. For placement and configuration of the hardware jumpers inside the unit, please refer to the configuration guide in Appendix A.

¹ Assuming use of a CAT5 twisted pair cable

RS485 port 1 (standard)

This port is always available on the RTCU AX9 pro unit and is not shared with any other resources. RS485 signals are available on the angled back terminals.

If TER1 jumper is inserted a 120Ω endpoint resistor is enabled, for location of TER1 refer to Appendix A

Standard RS485 terminals.

Terminal Name	Description
RS485_1+	RS485 non-inverting signal for standard RS485 port
RS485_1-	RS485 inverting signal for standard RS485 port
SGND	Signal ground

The standard RS485 port must be addressed as **port 2** when using the VPL API, such as the serOpen function.

RS485 port 2 (optional)

If the optional RS485 port is installed and enabled, RS485 will be available on the angled front terminals.

Internally this optional RS485 port and the RS232 serial port 1 shares the same signals and only one can be active at any given time.

If TER2 jumper is inserted a 120Ω endpoint resistor is enabled, for location of TER2 refer to Appendix A

Optional RS485 terminals.

Terminal Name	Description
RS485_2+	RS485 non-inverting signal for optional RS485 port
RS485_2-	RS485 inverting signal for optional RS485 port
SGND	Signal ground

The optional RS485 port must be addressed as **port 0** when using the VPL API, such as the serOpen function.

1-Wire

The 1-Wire bus is available on the angled front row terminals. All 1-Wire communication goes through this single pin and all 1-Wire devices connected to this pin retrieves its power directly from the bus (called parasitic power). By this only two wires are needed: the 1-wire signal and the ground reference – allowing minimal cable installations.

For 1-Wire ID-Button readers, which include a built-in LED, a dedicated output is available for this purpose. Please consult the RTCU IDE on-line help for further information.

Further information regarding 1-wire networks, topology and limitations can be found in the application note area on the Logic IO webpage.

1-Wire terminals.

Name	Description
1Wire	1-Wire bus for ID-Button / Temperature sensor
1Wire-LED	1-Wire ID-Button LED output
SGND	Signal ground

DC-Out

Two DC outputs are available on the RTCU AX9 pro for supplying external equipment; a 3.3V and a 12V output. It is possible to control these DC outputs in order to save power. Both DC outputs are short circuit- (to ground), ESD- and transient protected. Make sure not exceed the current specification of the outputs and be aware of inrush currents of the external equipment may exceed the specifications. It is recommended to install a fuse to protect the outputs.

The DC outputs must be enabled from the application. Please consult the RTCU IDE on-line manual for more information.

3.3V DC-Out

The +3.3V DC output can supply a maximum of 400mA and is available on the angled back row terminals.

12V DC-Out

The +12V DC output can supply a maximum of 750mA and is available on the top row of the stacked terminals.

DC-Out terminals.

Terminal Name	Description
DCOUT33	+3.3V / 400mA DC output for external equipment.
DCOUT12	+12V / 750mA DC output for external equipment.
SGND	Signal ground

LED's

Three bi-colored (red and green) and a single yellow LED indicators are present on the front of the RTCU AX9 pro (*see the graphical view*). Two bi-colored LED's (A and B) are available to the user and the remaining two LED's (S1 and S2) are signaling the status and possible errors of the RTCU unit.

The user control LED one through four for application specific signaling purposes.

- LED named A on the front, consists of LED 1 (green) and LED 2 (red)
- LED named B on the front, consists of LED 3 (green) and LED 4 (red)

They are easily accessed from within the VPL program, and it is possible to mix the LED's to obtain a third color, yellow. Please consult the RTCU IDE on-line manual for more information.

The remaining two LED's (S1 and S2) are used by the RTCU to signal the status of the unit. The different patterns are listed in the table below.

The S1 LED indicates different states of the unit; for example an active RTCU IDE connection (or another program, supporting the RTCU protocol, RACP) and battery charging.

S1: System LED1 pattern overview.

Pattern	Description
Fastest blinking, green	The unit is initializing, preparing to start the VPL program
Fast blinking, green (or yellow)	The VPL program is not executing, but stopped by the reset/diagnostic switch.
500ms On / 500ms Off green (or yellow)	The unit is executing the VPL program
1.5s On / 0.5s Off. green (or yellow)	The unit is executing the VPL program and charging the internal back-up battery.
Fast blinking, red (or yellow)	A runtime error has been detected in the program. Use the RTCU IDE to obtain the fault log.
Alternating Fast/Slow, red (or yellow)	The unit has lost its Firmware! This can only happen if, during a firmware upgrade, the RTCU Unit loses power, or the communication is lost completely. In this case, simply upload the firmware to the unit again.
75ms On / 925ms Off	Execution speed is different from full-speed.

The S1 LED will blink yellow when the RTCU AX9 pro is connected to RTCU IDE.

The single yellow LED is signaling either the GSM module activity or if all other LED's are off it will signal that the RTCU is in the Wait-For-Event low power state. Please see the table below:

S2: System LED2 pattern overview (GSM activity and “Wait-For-Event”)

Pattern	Operating Status
Off	The GSM module is turned off
600 ms On / 600 ms Off	No SIM card inserted or no PIN code entered, or network search in progress, or ongoing user authentication, or network logon in progress.
75 ms On / 3 s Off	Logged to the network. No call in progress.
75 ms On / 75 ms Off / 75 ms On / 3 s OFF	A GPRS session is active
Flashing	Indicates GPRS data transfer.
On	Depending on type of call: <i>Voice call:</i> Connected to remote party. <i>Data call:</i> Connected to remote party or exchange of parameters while setting up or disconnecting a call.
8 s OFF / 10 ms ON	The RTCU unit is in Wait-For-Event low power state.

Switches

DIP-Switch

The RTCU AX9 pro unit contains four dipswitches, where three of them are available for the application to use (*fourth dipswitch is reserved for future use.*) The dipswitches are located inside the unit (*see drawing below or graphical view*)

To use the dipswitch in the RTCU IDE declare a Boolean input variable, and define it as a dipswitch in the RTCU IDE Job variable configuration dialog.

System switch (Reset)

The RTCU AX9 pro unit contains a combined reset/diagnostic switch. This switch is accessible from the inside of the unit (*see drawing below or graphical view*) It's necessary to use a small object, for example the tip of a pencil.

By activating the switch shortly the RTCU unit will do a complete reset, as if the power was removed and re-applied. If the reset switch is held down for approx. 3 seconds² the VPL program/project uploaded to the unit will not be started and the unit will turn on the GSM module and establish connection to the GSM network and to GPRS / Gateway (if configured). This method will also activate the unit if it is powered down due to a power fail. The feature is very helpful when maintenance without power is needed. To “exit” (power down the unit again) from this mode simply activate the reset switch shortly. The status indicator indicates the state by fast blinking green or yellow as stated above.

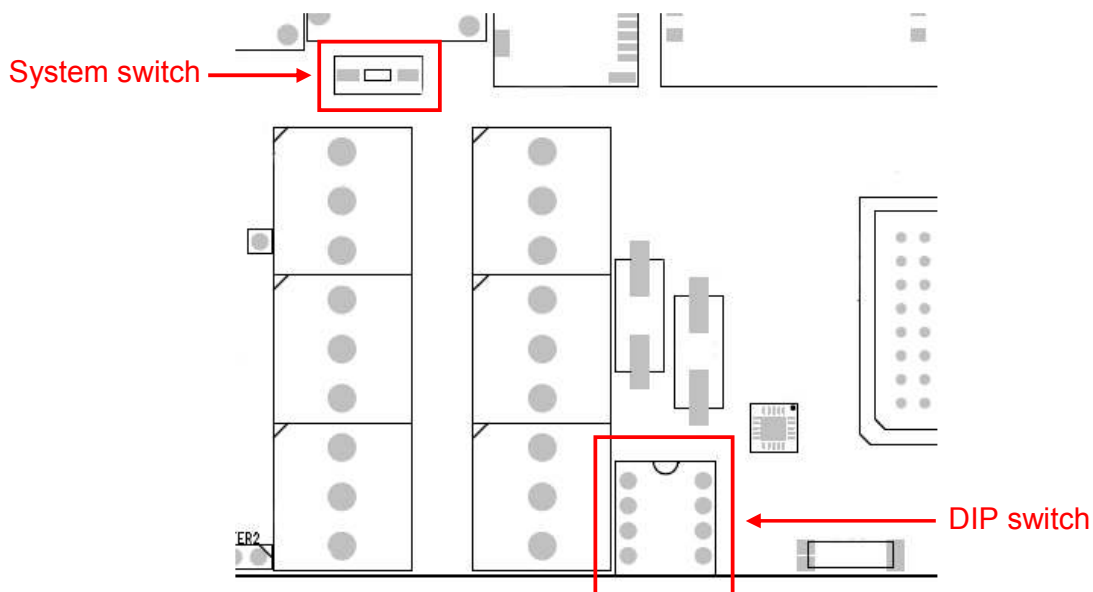

² System LED S2 will flash three times when this state is entered.

Internal Li-Ion battery

The RTCU AX9 pro contains an internal Li-Ion battery for operation even during an external power fail. Making it possible to report power losses etc. Please note that when external power is removed the unit will by default be powered down. This setting can be changed though and is documented in the RTCU IDE on-line manual. The relay outputs are disabled when a power fail occurs because the internal battery can't provide the supply voltage needed for the relays.

The battery charging is completely automated and handled internally by the RTCU unit – leaving no need for user interaction. Different kinds of functions (Battery Low, Charger Enable, Charging status etc) are available for the user though. Please consult the RTCU-IDE on-line manual for more information.

The charge current is very high, for shorter charge time, as specified in the technical specifications. Make sure both power supply and cables can handle the current.

The battery will be charged whenever a power fail has occurred to establish the capacity making the battery ready for the next power fail. A maintenance charge will start every 100-hour after the last charge. This is to compensate for the battery self-discharge etc. The battery cannot be charged above 45°C or below -10°C. The RTCU unit will automatically detect the temperature and terminate the charging process if the temperature is out of this range.

The temperature has very high influence on the battery capacity. At 0°C the capacity has dropped to 60% of the initial capacity and it falls dramatically at lower temperatures. The battery cycle (numbers of charges and discharges) has also influence on the capacity. After 300 cycles the capacity has dropped to approximately 80% of the initial capacity.

Warning:

Misusing the RTCU AX9 pro unit may cause the built-in battery security circuit to be damaged.

- Do not place the RTCU unit in high temperature locations such as direct sunlight or near engines. Using the RTCU unit in this environment may result in loss of battery performance and a shortened life expectancy.
- Do not expose the unit to water, salt water or allow the battery to get wet.
- Avoid strong impacts and shocks.

For more information regarding the environmental limitations see specification page or consult the RTCU AX9 pro Datasheet.

GSM

For GSM and GPRS communication an industry leading QUAD band (850/900/1800/1900MHz) GSM module is used.

The RTCU AX9 pro supports:

- Digitized voice
- SMS (Text and PDU)
- GPRS Multislot class 10. Support for simultaneous Voice and GPRS (suspended)
- CSD (Datacall)

GSM Antenna(s)

The RTCU AX9 pro unit is available in two different versions:

- RTCU AX9 pro with internal quad band chip antenna.
- RTCU AX9 pro with external SMA female connector for connecting a suitable GSM quad band antenna (850/900/1800/1900MHz)

When installing the RTCU AX9 pro (*internal antenna version*) unit or the external GSM antenna (*external antenna version*), please make sure that the antenna is not in close proximity of metallic parts or anything else that can influence the efficiency of the GSM antenna.

SIM-Card

The RTCU AX9 pro unit contains a standard SIM card reader which is located inside the unit (*see drawing on next page or graphical view*) and is easily accessed. The SIM card reader is lid based with a mechanical lock system for secure installation of the SIM card. Please refer to Appendix B for SIM card installation guide.

Micro SD card reader

The RTCU AX9 pro unit has a standard Micro SD card reader which is located inside the unit (see drawing below or graphical view). The Micro SD card reader is a lid based system with mechanical lock for reliable insertion and operation.

The RTCU AX9 pro supports a FAT file-system for standard PC-compatibility. Up to 2 GByte capacity is supported. Please refer to Appendix C for SD-Card installation guide.

Both the card detect and the write protect³ information is available to the user through the application. Please consult the RTCU IDE on-line help for more information. Avoid removing the Micro SD card during access to the card.

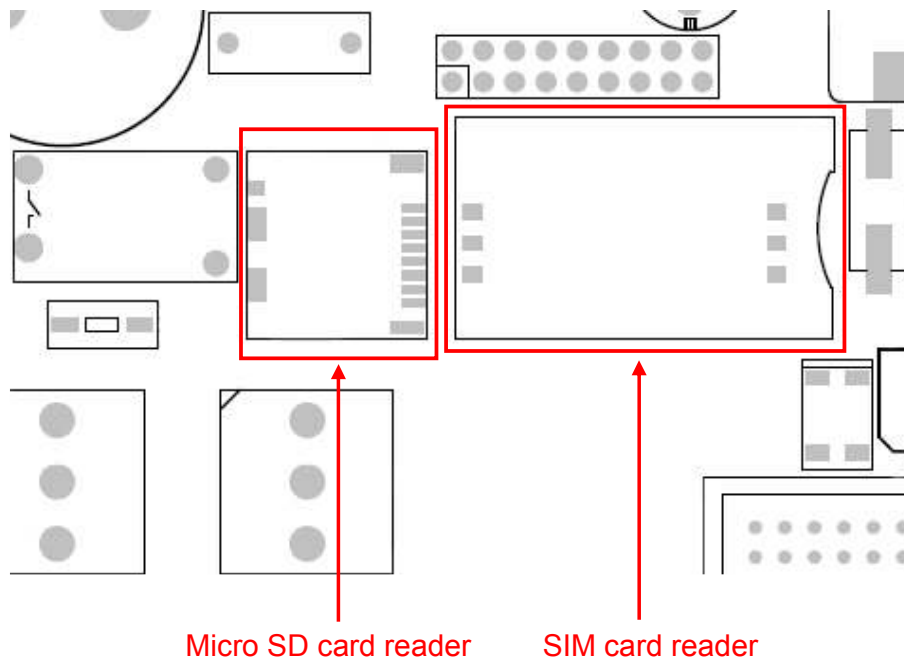

³ There is lack of hardware implementation of this signal, but for compatibility reason the software function will always return “not write protected”.

868MHz ISM RF

The RTCU AX9 is provided with an ISM band RF module, which gives the unit ability of communicating with other devices wireless. The unit communicates in the 868 MHz frequency band. The RF module hardware is setup to comply with the European EN 300 220 requirements. Please consult the RTCU IDE on-line help for more information on how to configure the RF module.

In the table below the specifications of the RF module is shown:

Data	Value
Max. Output Power	+10 dBm
Frequency	869,4 MHz
Modulation	GFSK
Max. Baud Rate	38,4 kbaud

Please Note: Listen Before Talk (LBT)⁴ functionality to comply with EN 300 220 is implemented in the RF module. If the unit is installed in an environment with disturbance in the same frequency band, difficulties in RF transmission will be observed.

Barcode

The barcode label found on the RTCU AX9 pro unit contains the serial number. The first three digits in the serial-number identify the unit type, as follows:

- **208:** RTCU AX9 pro or RTCU AX9 pro-x.
- **233:** RTCU AX9 pro.
- **234:** RTCU AX9 pro-x

The barcode format used: 2/5 Interleaved with Check Digit

⁴ LBT is a term used in radio communication whereby a radio transmitter senses its radio environment before it starts a transmission

Power consumption

Detailed information on the maximum power consumption of the RTCU AX9 pro unit in different states and different supply types is listed below.

Please Note: Values marked with (*) is average and should be considered as guidelines as they may vary depending on the GSM signal strength.

External DC supply

When the RTCU AX9 pro unit is powered from an external DC power source the power consumptions will be as follows.

Maximum power consumption.

	8V	12V	30V		
Unit active	65	50	20	mA	
Unit active with GSM on*	80	60	25	mA	GSM idle @ -67dBm*
Unit active RF sending	65	55	20	mA	
Unit active while charging	870	530	290	mA	
Unit in power-down	1.3	0.8	0.4	mA	Restart on DIN5, RTC
Unit in "wait for event"	1.3	0.8	0.4	mA	Resume on DIN, RTC
Unit in "wait for event"	10	6	3	mA	Resume on RS232
Unit in "wait for event"	26	20	8	mA	Resume on GSM activity

Internal battery

If the external power source is removed and the internal battery is enabled the power consumption from the battery will be as listed below.

Maximum power consumption

	BAT		
Unit active	85	mA	
Unit active with GSM on*	105	mA	GSM idle @ -67dBm*
Unit in power-down	1.5	mA	Restart on DIN5, RTC
Unit in "wait for event"	1.5	mA	Resume on DIN, RTC
Unit in "wait for event"	12	mA	Resume on RS232
Unit in "wait for event"	35	mA	Resume on GSM activity

Note: Power consumption from a fully charged battery.

External AC supply

When the RTCU AX9 pro unit is powered from an external AC the power consumptions will be as follows.

Maximum power consumption.

	220VAC		
Unit active	8	VA	
Unit active with GSM on*	8.5	VA	GSM idle @ -67dBm*
Unit active RF sending	8.3	VA	
Unit active while charging	17.2	VA	
Unit in power-down	6.6	VA	Restart on DIN5, RTC
Unit in "wait for event"	6.6	VA	Resume on DIN, RTC
Unit in "wait for event"	7	VA	Resume on RS232
Unit in "wait for event"	7	VA	Resume on GSM activity

Specifications for the RTCU AX9 pro

Power supply	Min	Typ		Max		
		DC	AC			
On-board Li-Ion Battery Pack		1900				mAh
Operating Voltage AC	85	-	-	265	VAC	Fused
Operating Voltage DC	8	-	-	36	VDC	Protected against wrong polarity.
Unit Active		50 mA	8 VA			<i>Typical measurements @ 12 VDC / 220 VAC.</i> <i>All outputs are OFF</i> GSM idle @ -63 dBm @ 10 dBm Resume on: DI, RTC Resume on: RS232 Resume on: GSM
Unit Active with GSM on		60 mA	8,5 VA			
Unit Active with RF Sending		55 mA	8,5 VA			
Unit Active while charging		530 mA	17,5 VA			
Unit in Power-down		0,8 mA	6,6 VA			
Unit in "Wait for Event"		0,8 mA	7 VA			
Unit in "Wait for Event"		6 mA	7 VA			
Unit in "Wait for Event", GSM On		20 mA	7 VA			
Digital Outputs (Relay SPST)	-	-	5	A	@ 250VAC / @ 30VDC	
Digital Inputs	Logic "High"	6	-	40	VDC	All inputs are protected against transients and low-pass filtered
	Logic "Low"	-5	-	3	VDC	
Analog Outputs	0	-	10	VDC	Resolution is 10 bits. Max load: 250 Ω. Accuracy @ 25°C ±1,5 % FSR.	
	0	-	20	mA		
Analog Inputs	0	-	10	VDC	Resolution is 10 bits. All inputs are protected against transients and low-pass filtered. Accuracy @ 25°C ±1,5 % FSR.	
	0	-	20	mA		
<ul style="list-style-type: none"> GSM Radio Frequency GSM Transmit Power GPRS Packet Mode 	850 / 900 / 1800 / 1900 MHz Class 4 (2W@850/900 MHz) Class 1 (1W@1800/1900 MHz) Class B, Multislot 10					
On-board ISM RF <ul style="list-style-type: none"> Frequency Channel Spacing Maximum Transmit Power Receiver Sensitivity Operating Range 	869,4 MHz 250 kHz +10 dBm -112 dBm Indoor: up to 15 m / Outdoor: up to 50 m					
Storage Temperature	-30	-	+65	°C	External Interfaces: <ul style="list-style-type: none"> 3 PG11, 2 PG9(blind) cable glands for cable entry SMA-Female for GSM Antenna (Only with external GSM antenna) Internal Interfaces: <ul style="list-style-type: none"> USB B Micro SD-card reader SIM-card reader Easy accessible screw terminals 	
Operating Temperature (According to GSM 11.10 specification)	-25	-	+55	°C		
Restricted Operation (deviation from the GSM specification may occur)	-30	-	+65	°C		
Charging Temperature	-10	-	+45	°C		
Humidity (non condensing)	5	-	90	%		
Weight	0,680			Kg		
External dimensions	W 130 x H 180 x D 60 mm			Without SMA connector, and PG11 and PG9 cable glands		
Ingress Protection (IP)	IP-67 (int. ant.) / IP-66 (ext. ant.)					
Approvals	EN 61000-6-2 EN 61000-6-3			 EU EMC Directive 2004/108/EU		

Technical data subject to change

Appendix A – Unit configuration guide

The RTCU AX9 pro has many features and some of them requires configuration by setting hardware jumpers inside the unit. A brief overview over the jumper settings can be found on the following table.

Feature	Jumper	State	Default state
Communication	TER1 (<i>RS485_1</i>)	Installed	120Ω resistor enabled
		Not installed	120Ω resistor disabled (<i>default</i>)
	TER2 (<i>RS485_2</i>)	Installed	120Ω resistor enabled
		Not installed	120Ω resistor disabled (<i>default</i>)
Analog input	JPAI1	Installed	AI1 current measurement
		Not installed	AI1 voltage measurement (<i>default</i>)
	JPAI2	Installed	AI2 current measurement
		Not installed	AI2 voltage measurement (<i>default</i>)
JPAI3	Installed	AI3 current measurement	
	Not installed	AI3 voltage measurement (<i>default</i>)	
JPAI4	Installed	AI4 current measurement	
	Not installed	AI4 voltage measurement (<i>default</i>)	
Analog output	JPAO1	Position C	AO1 current
		Position V	AO1 voltage (<i>default</i>)
	JPAO2	Position C	AO2 current
		Position V	AO2 voltage (<i>default</i>)
JPAO3	Position C	AO3 current	
	Position V	AO3 voltage (<i>default</i>)	
JPAO4	Position C	AO4 current	
	Position V	AO4 voltage (<i>default</i>)	
Digital input	JPDI1	Position S	DI1 S0
		Position N	DI1 normal (<i>default</i>)
	JPDI2	Position S	DI2 S0
		Position N	DI2 normal (<i>default</i>)
JPDI3	Position S	DI3 S0	
	Position N	DI3 normal (<i>default</i>)	
JPDI4	Position S	DI4 S0	
	Position N	DI4 normal (<i>default</i>)	

TER1 and TER2

Enables/disables on-board 120Ω line termination resistors which are according to standards; RS485 communication requires a proper line termination value (120Ω *assuming a CAT5 twisted pair cable is used*) resistors in both ends of the bus. If the RTCU AX9 pro unit is used as endpoint the relevant jumper can be installed.

JPAI1, JPAI2, JPAI3 and JPAI4

These jumpers are used to select between current and voltage input. With a jumper installed on the relevant analog input it will measure current between 0-20mA.

JPAO1, JPAO2, JPAO3 and JPAO4

These jumpers are used to select either current or voltage output. With the relevant jumper installed in position “C” the output is a current between 0-20mA, when installed in position “V” output is a voltage between 0-10V.

JPDI1, JPDI2, JPDI3 and JPDI4

These select either normal or Class A S0 input for DIN1-4. With the relevant jumper installed in position “S” the input is configured to S0, when installed in position “N” the input is a normal digital input.

The following figure shows the location of the jumpers when the lid of the unit is removed. Red lined boxes show default state of the jumpers.

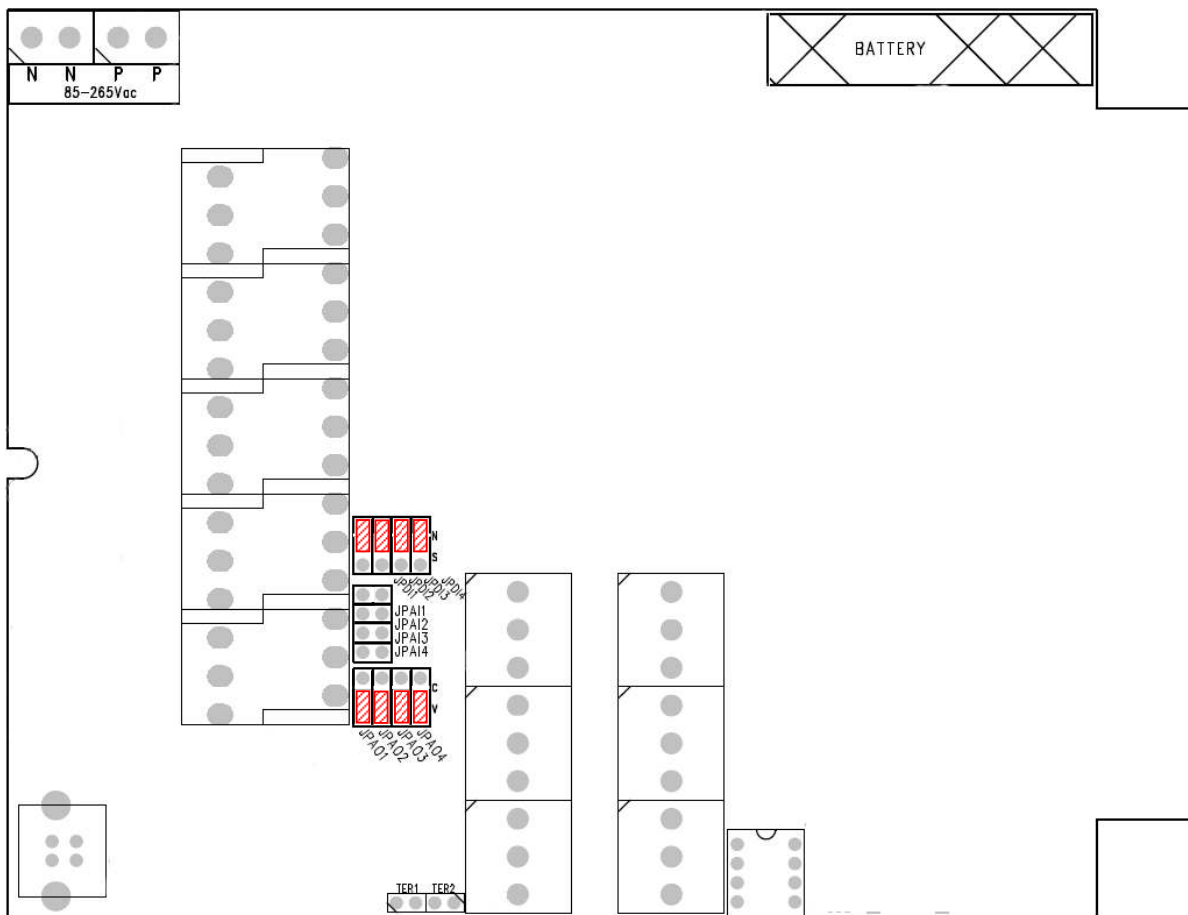

Appendix B – Installing the SIM card

The SIM card reader is a lid based type with a mechanical lock for secure installation of the SIM card.

Open the hinged lid of the SIM card reader, orientate the card as showed below, and insert it into the lid of the card reader. Close the lid, and slide the metal locking mechanism to the locked position as shown with an arrow and text on the lid, until a click is heard.

To remove the card slide the metal locking mechanism to the unlocked position as shown with an arrow and text on the lid, and open the lid. The SIM card can now be removed.

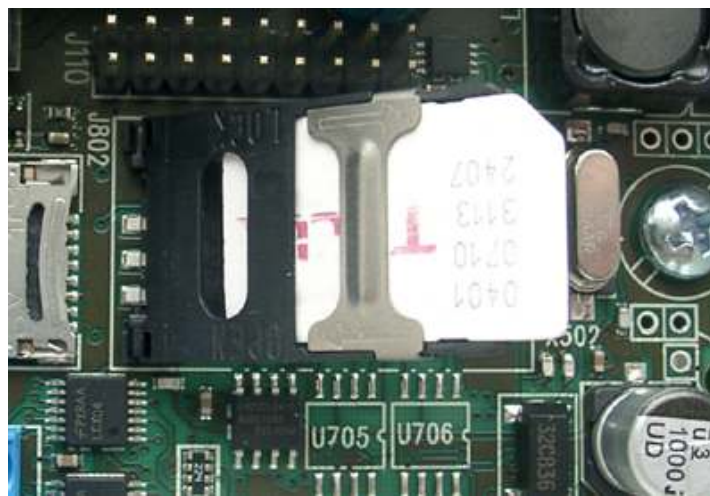

SIM card orientation.

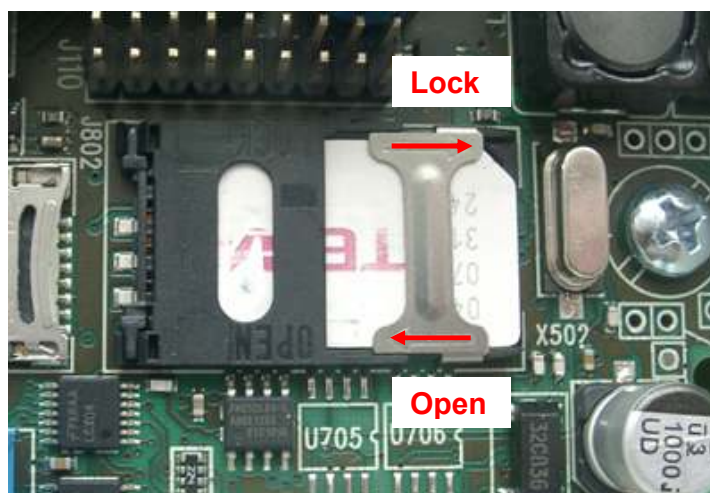

SIM inserted and locked

Appendix C – Installing the Micro SD card

To insert a Micro SD card into the reader open the hinged lid of the card reader, orientate it as shown below, and push the card into the lid. Close the lid, and slide the metal lid in the direction that is shown with an arrow on the lid, until a click is heard.

Remove the card by sliding the lid in the direction that is shown with an arrow on the lid, and then open the lid. Avoid removing the Micro SD card during access to the card.



Micro SD card orientation

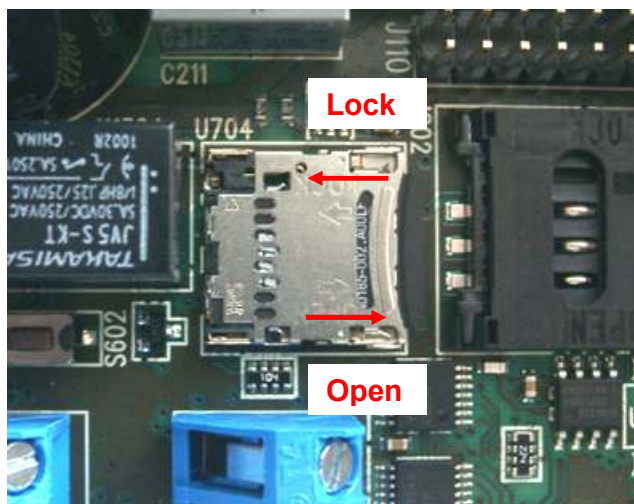

Micro SD card inserted and locked